

Teollisuusrengashinnasto



1.7.2010

Kuormitustunnukset (Li) ja suorituskykyluokat

Kuormitustunnukset (Li)

LI	KG	LI	KG	LI	KG	LI	KG	LI	KG	LI	KG
50	190	75	387	100	800	125	1650	150	3350	175	6900
51	195	76	400	101	825	126	1700	151	3450	176	7100
52	200	77	412	102	850	127	1750	152	3550	177	7300
53	206	78	425	103	875	128	1800	153	3650	178	7500
54	212	79	437	104	900	129	1850	154	3750	179	7750
55	218			105	925			155	3875		
56	224	80	450	106	950	130	1900	156	4000	180	8000
57	230	81	462	107	975	131	1950	157	4125	181	8250
58	236	82	475	108	1000	132	2000	158	4250	182	8500
59	243	83	487	109	1030	133	2060	159	4375	183	8750
		84	500			134	2120			184	9000
60	250	85	515	110	1060	135	2180	160	4500	185	9250
61	257	86	530	111	1090	136	2240	161	4625	186	9500
62	265	87	545	112	1120	137	2300	162	4750	187	9750
63	272	88	560	113	1150	138	2360	163	4875	188	10000
64	280	89	580	114	1180	139	2430	164	5000	189	10300
65	290			115	1215			165	5150		
66	300	90	600	116	1250	140	2500	166	5300	190	10600
67	307	91	615	117	1285	141	2575	167	5450	191	10900
68	315	92	630	118	1320	142	2650	168	5600	192	11200
69	325	93	650	119	1360	143	2725	169	5800	193	11500
		94	670			144	2800			194	11800
70	335	95	690	120	1400	145	2900	170	6000	195	12150
71	345	96	710	121	1450	146	3000	171	6150	196	12500
72	355	97	730	122	1500	147	3075	172	6300	197	12850
73	365	98	750	123	1550	148	3150	173	6500	198	13200
74	375	99	775	124	1600	149	3250	174	6700	199	13600





















































Suorituskykyluokat

Tunnus Nopeus (km/h)

A1	A2	A3	A4	A5	A6	A7	A8	B	C	D	E	F	G	J
5	10	15	20	25	30	35	40	50	60	65	70	80	90	100

K	L	M	N	P	Q	R	S	T	U	H	V	W	Y	Z
110	120	130	140	150	160	170	180	190	200	210	240	270	300	240 -

TEOLLISUUSRENKAAT INDUSTRI DÄCK

	IC 40 Diagonal Extra Deep	Conti RV 20 Radial Standard	Conti RT 20 Radial Extra Deep	SC 20 Clean	Robust SC 20	SCEasy SC 20
Kilometri %	100	100	200	200	240	300
Hinta %	100	120	135	260	200	300
Hinta/käyttöikä-suhde	100	80	120	80	80	100
Turvallisuus nostoissa						
Pito, jarrutuskyky						
Kulutuspinnan pistovaurionkestävyys						
Sivuvaurionkestävyys						
Vierimisvastus						
Nopeus						
Ajomukavuus						
Lämmönkehitys						
 = erittäin hyvä  = hyvä  = keskimääräinen  = huono						

EUROOPAN YKKÖSET



Koko	PR	LI/SI	Pintamalli	Tuotenro	SVH alv 0%	SVH alv 23%	Huomautus
4 tuuman vanne							
3.00-4	4	51A5	IC10	07003300000	28,00	34,44	
4.00-4	6	77A5	IC10	07003400000	53,00	65,19	
8 tuuman vanne							
4.00-8	6	90A5	IC10	07003600000	68,00	83,64	
	10	97A5	IC10	07003620000	73,00	89,79	
125/75R8 (15x4.5R8) Radial TL	12	100A5	IC70	07450650000	140,00	172,20	
Tiivistenauha			TSR 125/75R8 TL (3.00)	07930020000	46,00	56,58	
5.00-8	8	106A5	IC40	07020700000	101,00	124,23	
SET			SET IC40	07060080000	141,00	173,43	sisältää renkaan, sisärenkaan ja vannenauhan
5.00R8 Radial TL	10	111A5	IC70	07450700000	127,00	156,21	
Tiivistenauha			TSR 5.00R8 TL (3.00)	07930170000	46,00	56,58	
150/75R8 (16X6R8) Radial TL	16	113A5	IC70	07450840000	146,00	179,58	
Tiivistenauha			TSR 150/75R8 TL (4.33)	07930030000	46,00	56,58	
18x7-8	16	125A5	IC40	07020880000	154,00	189,42	
SET			SET IC40	07060170000	182,00	223,86	sisältää renkaan, sisärenkaan ja vannenauhan
180/70R8 (18X7R8) Radial TL			ContiRT20	07300290000	177,00	217,71	
			ContiRV20	07300110000	159,00	195,57	
Tiivistenauha			TSR 180/70R8 TL (4.33)	07930030000	46,00	56,58	
9 tuuman vanne							
6.00-9	12	121A5	IC40	07021010000	155,00	190,65	
SET			SET IC40	07060220000	182,00	223,86	sisältää renkaan, sisärenkaan ja vannenauhan
6.00R9 Radial TL			ContiRT20	07300270000	194,00	238,62	
			ContiRV20	07100010000	174,00	214,02	
			TSR 6.00R9 TL (4.00)	07930040000	46,00	56,58	

IC 40

Conti RT 20

Conti RV 20

Koko	PR	LI/SI	Pintamalli	Tuotenro	SVH alv 0%	SVH alv 23%	Huomautus
9 tuuman vanne							
21x8-9	14	131A5	IC40	07021040000	211,00	259,53	
SET			SET IC40	07060260000	229,00	281,67	sisältää renkaan, sisärenkaan ja vannenauhan
10 tuuman vanne							
6.50-10	14	128A5	IC40	07021060000	218,00	268,14	
SET			SET IC40	07060360000	234,00	287,82	
6.50R10 Radial TL			ContiRT20	07300280000	245,00	301,35	
			ContiRV20	07100130000	219,00	269,37	
Tiivistenauha			TSR 6.50R10 TL (5.00)	07930050000	60,00	73,80	
23x9-10	20	142A5	IC40	07021110000	295,00	362,85	sisältää renkaan, sisärenkaan ja vannenauhan
SET			SET IC40	07060480000	321,00	394,83	
225/75R10 (23x9R10) Radial TL			ContiRT20	07300260000	350,00	430,50	
			ContiRV20	07300390000	313,00	384,99	
Tiivistenauha			TSR 225/75R10 TL (6.50)	07930070000	60,00	73,80	
12 tuuman vanne							
7.00-12	14	134A5	IC40	07021210000	230,00	282,90	
SET			SET IC40	07060530000	259,00	318,57	sisältää renkaan, sisärenkaan ja vannenauhan
	16	136A5	IC40	07021220000	245,00	301,35	
SET			SET IC40	07060580000	273,00	335,79	sisältää renkaan, sisärenkaan ja vannenauhan
7.00R12 Radial TL			ContiRT20	07300350000	315,00	387,45	
			ContiRV20	07300070000	281,00	345,63	
Tiivistenauha			TSR 7.00R12 TL (5.00)	07930010000	67,00	82,41	
27x10-12	14	143A5	IC40	07021330000	417,00	512,91	
SET			SET IC40	07060630000	450,00	553,50	sisältää renkaan, sisärenkaan ja vannenauhan
	20	152A5	IC40	07021360000	475,00	584,25	
SET			SET IC40	07060650000	502,00	617,46	sisältää renkaan, sisärenkaan ja vannenauhan
250/75R12 (27x10R12) Radial TL			ContiRT20	07300320000	544,00	669,12	
Tiivistenauha			TSR 250/75R12 TL (8.00)	07930110000	67,00	82,41	

IC 40

Conti RT 20

Conti RV 20

Koko	PR	LI/SI	Pintamalli	Tuotenro	SVH alv 0%	SVH alv 23%	Huomautus
13 tuuman vanne							
23x5	6	113A5	IC40	07022200000	157,00	193,11	
25x6	8	126A5	IC40	07022300000	238,00	292,74	
165R13 Radial TL		102A6	ContiRV20	07100140000	237,00	291,51	
15 tuuman vanne							
7.00-15	12	138A5	IC10	07006660000	279,00	343,17	
7.00R15 Radial TL		143A5	ContiRV20	07300100000	310,00	381,30	
Tiivistenauha			TSR 7.00R15 TL (5.50)	07930060000	85,00	104,55	
7.50-15	14	144A5	IC40	07022700000	336,00	413,28	
SET			SET IC40	07060760000	400,00	492,00	sisältää renkaan, sisärenkaan ja vannenauhan
7.50R15 Radial TL			ContiRV20	07300120000	364,00	447,72	
Tiivistenauha			TSR 7.50R15 TL (6.00/6.50)	07930080000	85,00	104,55	
8.25-15	18	153A5	IC40	07022760000	447,00	549,81	
SET			SET IC40	07060820000	477,00	586,71	sisältää renkaan, sisärenkaan ja vannenauhan
8.25R15 Radial TL			ContiRT20	07300370000	524,00	644,52	
Tiivistenauha			ContiRV20	07300400000	468,00	575,64	
Tiivistenauha			TSR 8.25R15 TL (6.50)	07930000000	85,00	104,55	
28x8-15 (8.15-15)	14	146A5	IC40	07021800000	396,00	487,08	
SET			SET IC40	07060880000	432,00	531,36	sisältää renkaan, sisärenkaan ja vannenauhan
225/75R15 (28x9R15) (8.15R15) Radial TL		149A5	ContiRT20	07300300000	486,00	597,78	
Tiivistenauha			TSR 225/75R15 TL (7.00)	07930090000	67,00	82,41	
250-15	18	153A5	IC40	07022570000	279,00	343,17	
SET			SET IC40	07060920000	476,00	585,48	sisältää renkaan, sisärenkaan ja vannenauhan
250/70R15 (250R15) Radial TL			ContiRT20	07300240000	466,00	573,18	
Tiivistenauha			ContiRV20	07300430000	417,00	512,91	
Tiivistenauha			TSR 250/70R15 TL (7.00/7.50)	07930150000	85,00	104,55	

IC 40

Conti RT 20

Conti RV 20

Koko	PR	LI/SI	Pintamalli	Tuotenro	SVH alv 0%	SVH alv 23%	Huomautus
15 tuuman vanne							
300-15	22	165A5	IC40	07022640000	674,00	829,02	
SET			SET IC40	07060960000	726,00	892,98	sisältää renkaan, sisärenkaan ja vannenauhan
315/70R15 (300R15) Radial TL			ContiRT20	07300230000	817,00	1004,91	
			ContiRV20	07300410000	730,00	897,90	
Tiivistenauha			TSR 315/70R15 TL (8.00)	07930120000	85,00	104,55	
355/65-15 (350-15)	22	165A5	IC40	07423000000	944,00	1161,12	
SET			SET IC40	07463030000	1006,00	1237,38	sisältää renkaan, sisärenkaan ja vannenauhan
355/65R15 (350R15) Radial TL			ContiRT20	07300220000	1080,00	1328,40	
Tiivistenauha			TSR 355/65R15 TL (9.75)	07930140000	85,00	104,55	
20 tuuman vanne							
10.00-20	18	166A5	IC40	07300090000	872,00	1072,56	
SET			SET IC40	07062510000	939,00	1154,97	sisältää renkaan, sisärenkaan ja vannenauhan
10.00R20 (290/95R20) Radial TL			ContiRT20	07300310000	1016,00	1249,68	
Tiivistenauha			TSR 20"RadialTL (7.5/8.0/8.5)	07930100000	105,00	129,15	
12.00-20	20	176A5	IC40	07300080000	996,00	1225,08	
SET			SET IC40	07062500000	1063,00	1307,49	sisältää renkaan, sisärenkaan ja vannenauhan
12.00R20 (330/95R20) Radial TL			ContiRT20	07300360000	1447,00	1779,81	
			ContiRV20	07300420000	1293,00	1590,39	
Tiivistenauha			TSR 20"RadialTL (7.5/8.0/8.5)	07930100000	105,00	129,15	

CSEasy Robust

CSEasy Clean

Koko	Komponentti	Malli	Pintamalli	Tuotenro	SVH alv 0%	SVHalv 23%	Huomautus
8 tuuman vanne							
125/75-8	CSEasy Rengas	ROBUST	SC20	13780230000	264,00	324,72	
		CLEAN	SC20	13780100000	370,00	455,10	
	CSEasy ADAPTER 5.00-8 125/75-8			17306610000	75,00	92,25	sisältää pultit ja aluslevyt
5.00-8	CSEasy Rengas	ROBUST	SC20	13780330000	294,00	361,62	
		CLEAN	SC20	13780200000	413,00	507,99	
	CSEasy ADAPTER 5.00-8 125/75-8			17306610000	75,00	92,25	sisältää pultit ja aluslevyt
150/75-8	CSEasy Rengas	ROBUST	SC20	13780270000	361,00	444,03	
		CLEAN	SC20	13780140000	507,00	623,61	
	CSEasy ADAPTER 180/70 150/75-8			17306620000	82,00	100,86	sisältää pultit ja aluslevyt
180/70-8	CSEasy Rengas	ROBUST	SC20	13780210000	381,00	468,63	
		CLEAN	SC20	13780080000	534,00	656,82	
	CSEasy ADAPTER 180/70 150/75-8			17306620000	82,00	100,86	sisältää pultit ja aluslevyt
9 tuuman vanne							
6.00-9	CSEasy Rengas	ROBUST	SC20	13780290000	386,00	474,78	
		CLEAN	SC20	13780160000	541,00	665,43	
	CSEasy ADAPTER 6.00-9			17306730000	82,00	100,86	sisältää pultit ja aluslevyt
200/75-9	CSEasy Rengas	ROBUST	SC20	13780280000	492,00	605,16	
		CLEAN	SC20	13780150000	687,00	845,01	
	CSEasy ADAPTER 200/75-9			17306700000	87,00	107,01	sisältää pultit ja aluslevyt
10 tuuman vanne							
6.50-10	CSEasy Rengas	ROBUST	SC20	13780310000	552,00	678,96	
		CLEAN	SC20	13780180000	773,00	950,79	
	CSEasy ADAPTER 6.50-10			17306740000	87,00	107,01	sisältää pultit ja aluslevyt
225/75-10	CSEasy Rengas	ROBUST	SC20	13780240000	638,00	784,74	
		CLEAN	SC20	13780110000	894,00	1099,62	
	CSEasy ADAPTER 225/75-10			17306710000	105,00	129,15	sisältää pultit ja aluslevyt

Tubeless Sealing Ring

10 Yksinkertaista asennusvaihetta

1. VOITELE RENKAAN JALKA-ALUE JA SISÄPINTA AINAKIN KYLJEN PUOLEEN VÄLIIN SAAKKA

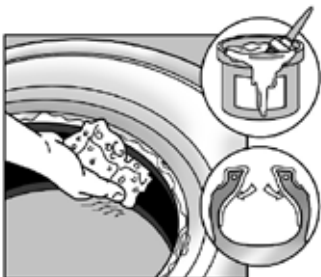

2. TAIVUTA TSR:STÄ "8" JA LAITA TOINEN PÄÄ MAHDOLLISIMMAN PITKÄLLE RENKAAN SISÄÄN



3. PYÖRÄYTÄ TSR RENKAAN SISÄÄN



4. PAINA TSR OIKEAAN ASENTOON PAINAMALLA TSR:N SIIVET RENKAAN SISÄPINTAA VASTEN. ON TÄRKEÄ VARMISTAA ETTÄ TSR ON SYMMETRISESTI RENKAAN SISÄLLÄ.



5. VOITELE RENKAAN SISÄLLÄ OLEVAN TSR:N NÄKYVÄT PINNAT.



6. VOITELE VANNE

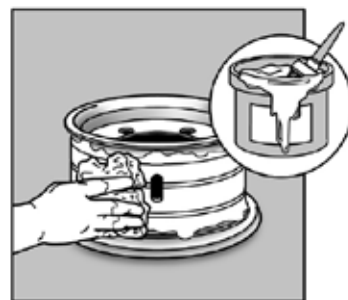

7. KOHDISTA VANNE SITEN ETTÄ VENTTIILIAUKKO ON LINJASSA TSR:N VENTTIILIN KANSSA JA ANNA RENKAAN PUDOTA ALAS. VARMISTA ETTÄ VENTTIILI ON KESKELLÄ AUUKOJA.

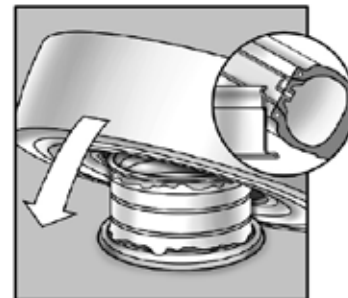

8. TYÖNNÄ VENTTIILI AUKOSTA VIPUA KÄYTTÄEN. OLE TARKKANA ETTÄ ET VÄÄNNÄ TSR:ÄÄ VINOON.

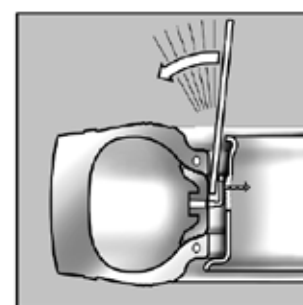

9. JATKA RENKAAN ASENTAMISTA KUTEN ASENETTAESSA PERINTEISTÄ RENGASTA.

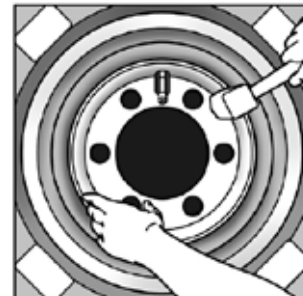

10. TÄYTÄ RENGAS YHDEN BARIN PAINEESEEN JA TARKASTA ETTÄ OSAT OVAT OIKEILLA PAIKOILLAAN. JATKA RENKAAN PAINAISTAMISTA 10 BARIN PAINEESEEN.

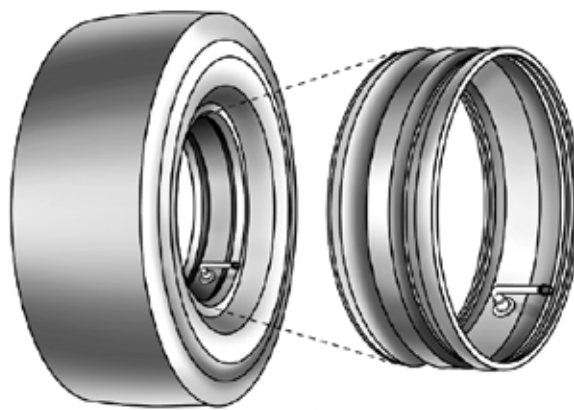
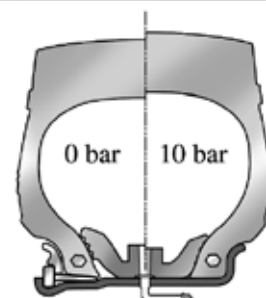

Robust SC 20

Clean SC 20

Koko	Vanne tyyppi	Vanne koko	Malli	Pintamalli	Tuotenro	SVH alv 0%	SVH alv 23%	Huomautus
8 tuuman vanne								
4.00-8	M/S	3.00-8	ROBUST	SC20	13760460000	145,00	178,35	
			CLEAN	SC20	13760830000	201,00	247,23	
	SIT	3.00-8	ROBUST	SC20	13760450000	161,00	198,03	
			CLEAN	SC20	13760820000	206,00	253,38	
125/75-8 (15x4.5-8)	M/S	3.00-8	ROBUST	SC20	13760170000	150,00	184,50	
			CLEAN	SC20	13760580000	211,00	259,53	
	SIT	3.00-8	ROBUST	SC20	13760090000	158,00	194,34	
			CLEAN	SC20	13760500000	220,00	270,60	
5.00-8	M/S	3.00-8	ROBUST	SC20	13760420000	196,00	241,08	
			CLEAN	SC20	13760790000	245,00	301,35	
	SIT	3.00-8	ROBUST	SC20	13760410000	203,00	249,69	
			CLEAN	SC20	13760780000	253,00	311,19	
150/75-8 (16x6-8)	S	4.33-8	ROBUST	SC20	13760180000	201,00	247,23	
			CLEAN	SC20	13760590000	293,00	360,39	
	SIT	4.33-8	ROBUST	SC20	13760100000	216,00	265,68	
			CLEAN	SC20	13760510000	307,00	377,61	
180/70-8 (18x7-8)	S	4.33-8	ROBUST	SC20	13797090000	230,00	282,90	
			CLEAN	SC20	13760930000	334,00	410,82	
	SIT	4.33-8	ROBUST	SC20	13797000000	245,00	301,35	
			CLEAN	SC20	13760920000	348,00	428,04	
9 tuuman vanne								
140/55-9	S	4.00-9	ROBUST	SC20	13760350000	180,00	221,40	
			CLEAN	SC20	13760750000	270,00	332,10	
	SIT	4.00-9	ROBUST	SC20	13760340000	187,00	230,01	
			CLEAN	SC20	13760740000	281,00	345,63	

Robust SC 20

Clean SC 20

Koko	Vanne tyyppi	Vanne koko	Malli	Pintamalli	Tuotenro	SVH alv 0%	SVH alv 23%	Huomautus
9 tuuman vanne								
6.00-9	M/S	4.00-9	ROBUST	SC20	13760400000	272,00	334,56	
			CLEAN	SC20	13760770000	373,00	458,79	
	SIT	4.00-9	ROBUST	SC20	13760390000	281,00	345,63	
			CLEAN	SC20	13760760000	394,00	484,62	
200/75-9 (21x8-9)	S	6.00-9	ROBUST	SC20	13760190000	464,00	570,72	
			CLEAN	SC20	13760600000	321,00	394,83	
	SIT	6.00-9	ROBUST	SC20	13760110000	495,00	608,85	
			CLEAN	SC20	13760520000	334,00	410,82	
10 tuuman vanne								
6.50-10	M/S	5.00-10	ROBUST	SC20	13760290000	358,00	440,34	
			CLEAN	SC20	13760690000	521,00	640,83	
	SIT	5.00-10	ROBUST	SC20	13760280000	371,00	456,33	
			CLEAN	SC20	13760680000	547,00	672,81	
180/60-10	S	5.00-10	ROBUST	SC20	13760480000	252,00	309,96	
			CLEAN	SC20	13760850000	378,00	464,94	
	SIT	5.00-10	ROBUST	SC20	13760470000	265,00	325,95	
			CLEAN	SC20	13760840000	398,00	489,54	
200/50-10	S	6.50-10	ROBUST	SC20	13773010000	293,00	360,39	
			CLEAN	SC20	13760870000	431,00	530,13	
	SIT	6.50-10	ROBUST	SC20	13773000000	302,00	371,46	
			CLEAN	SC20	13760860000	456,00	560,88	
225/75-10 (23x9-10)	S	6.50-10	ROBUST	SC20	13760200000	478,00	587,94	
			CLEAN	SC20	13760610000	697,00	857,31	
	SIT	6.50-10	ROBUST	SC20	13760120000	498,00	612,54	
			CLEAN	SC20	13760530000	734,00	902,82	

Robust SC 20



Clean SC 20



Koko	Vanne tyyppi	Vanne koko	Malli	Pintamalli	Tuotenro	SVH alv 0%	SVH alv 23%	Huomautus
12 tuuman vanne								
7.00-12	M/S	5.00-12	ROBUST	SC20	13760220000	432,00	531,36	
			CLEAN	SC20	13760630000	652,00	801,96	
	SIT	5.00-12	ROBUST	SC20	13760140000	472,00	580,56	
			CLEAN	SC20	13760550000	698,00	858,54	
250/60-12 (23x10-12)	S	8.00-12	ROBUST	SC20	13760230000	426,00	523,98	
			CLEAN	SC20	13760640000	618,00	760,14	
	SIT	8.00-12	ROBUST	SC20	13760150000	456,00	560,88	
			CLEAN	SC20	13760560000	660,00	811,80	
250/75-12 (27x10-12)	S	8.00-12	ROBUST	SC20	13760210000	639,00	785,97	
			CLEAN	SC20	13760620000	928,00	1141,44	
	SIT	8.00-12	ROBUST	SC20	13760130000	699,00	859,77	
			CLEAN	SC20	13760540000	995,00	1223,85	
315/45-12	S	10.00-12	ROBUST	SC20	13760270000	583,00	717,09	
			CLEAN	SC20	13760670000	875,00	1076,25	
	SIT	10.00-12	ROBUST	SC20	13760260000	615,00	756,45	
			CLEAN	SC20	13760660000	922,00	1134,06	
15 tuuman vanne								
7.00-15	S	5.50-15	ROBUST	SC20	13761130000	561,00	690,03	
	SIT	5.50-15	ROBUST	SC20	13761150000	597,00	734,31	
			CLEAN	SC20	13761140000	904,00	1111,92	
	7.50-15	S	6.50-15	ROBUST	SC20	13761160000	636,00	782,28
SIT		6.50-15	ROBUST	SC20	13761170000	662,00	814,26	
8.25-15	S	6.50-15	ROBUST	SC20	13791010000	780,00	959,40	
			CLEAN	SC20	13760890000	1161,00	1428,03	
	SIT	6.50-15	ROBUST	SC20	13791000000	836,00	1028,28	
			CLEAN	SC20	13760880000	1230,00	1512,90	

Robust SC 20

Clean SC 20

Koko	Vanne tyyppi	Vanne koko	Malli	Pintamalli	Tuotenro	SVH alv 0%	SVH alv 23%	Huomautus
15 tuuman vanne								
225/75-15 (28x9-15)	S	7.00-15	ROBUST	SC20	13760330000	621,00	763,83	
			CLEAN	SC20	13760730000	900,00	1107,00	
	SIT	7.00-15	ROBUST	SC20	13760320000	639,00	785,97	
			CLEAN	SC20	13760720000	954,00	1173,42	
250/70-15 (250-15)	S	7.00-15	ROBUST	SC20	13792050000	621,00	763,83	
			CLEAN	SC20	13760910000	938,00	1153,74	
250/70-15 (250-15)	S	7.50-15	ROBUST	SC20	13761260000	638,00	784,74	
			CLEAN	SC20	13761250000	958,00	1178,34	
	SIT	7.50-15	ROBUST	SC20	13792000000	673,00	827,79	
			CLEAN	SC20	13760900000	1005,00	1236,15	
315/70-15 (300-15)	S	8.00-15	ROBUST	SC20	13760240000	953,00	1172,19	
			CLEAN	SC20	13760650000	1557,00	1915,11	
	SIT	8.00-15	ROBUST	SC20	13760160000	1009,00	1241,07	
			CLEAN	SC20	13760570000	1626,00	1999,98	
355/45-15 (28x12.5-15)	S	9.75-15	ROBUST	SC20	13760440000	1055,00	1297,65	
			CLEAN	SC20	13760810000	1589,00	1954,47	
	SIT	9.75-15	ROBUST	SC20	13760430000	1094,00	1345,62	
			CLEAN	SC20	13760800000	1660,00	2041,80	
355/65-15 (350-15)	S	9.75-15	ROBUST	SC20	13760310000	1173,00	1442,79	
			CLEAN	SC20	13760710000	1767,00	2173,41	
	SIT	9.75-15	ROBUST	SC20	13760300000	1230,00	1512,90	
			CLEAN	SC20	13760700000	1881,00	2313,63	

Robust SC 20

Clean SC 20

Koko	Vanne tyyppi	Vanne koko	Malli	Pintamalli	Tuotenro	SVH alv 0%	SVH alv 23%	Huomautus
20 tuuman vanne								
8.25-20	S	6.50-20	ROBUST	SC20	13761180000	1061,00	1305,03	
	SIT	6.50-20	ROBUST	SC20	13761190000	1120,00	1377,60	
10.00-20(290/95-20)	S	7.50-20	ROBUST	SC20	13761010000	1516,00	1864,68	
			CLEAN	SC20	13761220000	2285,00	2810,55	
		8.00-20	ROBUST	SC20	13761020000	1577,00	1939,71	
			CLEAN	SC20	13761040000	2377,00	2923,71	
12.00-20 (335/95-20)	S	8.00-20	ROBUST	SC20	13761060000	2268,00	2789,64	
			ROBUST	SC20	13761070000	2339,00	2876,97	
		10.00-20	ROBUST	SC20	13761050000	2501,00	3076,23	
			SIT	8.50-20	ROBUST	SC20	13761080000	2441,00
24 tuuman vanne								
12.00-24 (335/95-24)	S	8.50-24	ROBUST	SC20	13761100000	2749,00	3381,27	
		10.00-24	CLEAN	SC20	13761090000	2876,00	3537,48	
14.00-24	S	10.00-24	ROBUST	SC20	13761110000	3000,00	3690,00	
			CLEAN	SC20	13761120000	4520,00	5559,60	

MH 20

Koko	Malli	Pintamalli	Tuotenro	SVH alv 0%	SVH alv 23%	Huomautus
75 mm vanne						
125/50-75	z L	MH20	13032000000	29,00	35,67	
100 mm vanne						
200/75-100	z L	MH20	1307000000	51,00	62,73	
105 mm vanne						
200/85-105	km A	MH20	13075050000	51,00	62,73	
120 mm vanne						
180/50-120	z A	MH20	13092010000	45,00	55,35	
230/75-120	z A	MH20	13102000000	57,00	70,11	
140 mm vanne						
250/75-140	z L	MH20	13120000000	60,00	73,80	
170 mm vanne						
230/50-170	z L	MH20	13162000000	56,00	68,88	
250/60-170	km L	MH20	13171000000	56,00	68,88	
190 mm vanne						
280/60-190	z L	MH20	13238000000	66,00	81,18	
270 mm vanne						
360/75-270	z L	MH20	13426000000	71,00	87,33	
305 mm vanne						
415/100-305	z L	MH20	13490000000	112,00	137,76	
405/130-305	z A	MH20	13502050000	122,00	150,06	
425/260-305	STB A	MH20	13520050000	386,00	474,78	

MH 20



Koko	Malli	Pintamalli	Tuotenro	SVH alv 0%	SVH alv 23%	Huomautus
410 mm vanne						
500/65-410	z L	MH20	13650000000	93,00	114,39	
560/100-410	STB A	MH20	13671050000	240,00	295,20	
590/120-410	z L	MH20	13682000000	267,00	328,41	
610/150-410	z A	MH20	13688050000	354,00	435,42	
	STB A	MH20	13690050000	467,00	574,41	
550/160-410	STB A	MH20	13695050000	332,00	408,36	
645/250-410	STB A-ROBUST	MH20	13705050000	825,00	1014,75	
480 mm vanne						
645/200-480	STB A-ROBUST	MH20	13733050000	748,00	920,04	
500 mm vanne						
760/250-500	STB A-ROBUST	MH20	13708070000	948,00	1166,04	

MPT 80

MPT 81

Koko	PR	LI/SI	Pintamalli	Tuotenro	SVH alv 0%	SVH alv 23%	Huomautus
16 tuuman vanne							
315/55R16		124F	MPT 81	04740350000	459,00	564,57	
20 tuuman vanne							
10.5R20	14	134J	MPT 80	05741420000	520,00	639,60	
275/80R20		134K	MPT 81	05742000000	575,00	707,25	
12.5R20	12	132J	MPT 80	05741550000	640,00	787,20	
	16	139J	MPT 80	05741560000	811,00	997,53	
	22	147J	MPT 80	05741620000	818,00	1006,14	
335/80R20		147K	MPT 81	05741920000	818,00	1006,14	
14.5R20	10	132J	MPT 80	05741550000	640,00	787,20	
	18	143J	MPT 80	05741560000	811,00	997,53	
	22	152J	MPT 80	05741620000	818,00	1006,14	
365/80R20		152K	MPT 81	05741950000	911,00	1120,53	

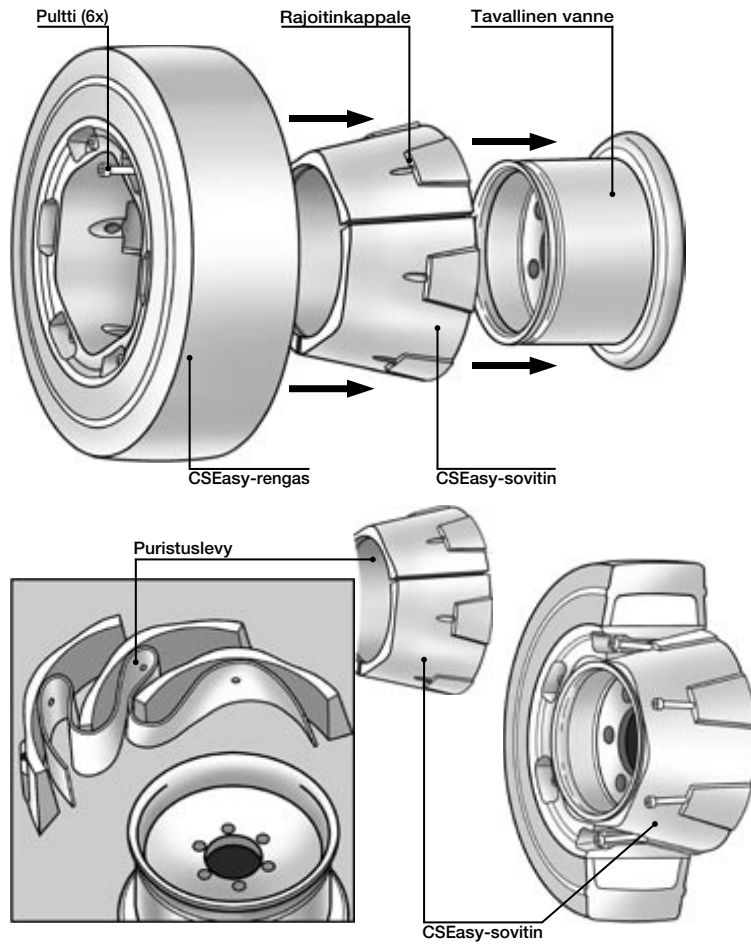
CSEasyn toimintaperiaate



Sisäsovitin koostuu kolmesta esiasennetusta lohkokosta ja yhdestä esiasennetusta kumisesta tukikappaleesta (puristuslevy).

Jos ajoneuvoon on asennettu vanhanmallinen joustorengas, sitä irrotettaessa on noudatettava joustorenkaiden tavanomaista irrotustapaa.

CSEasyn asennusohje

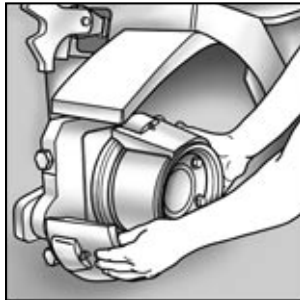

Jos ajoneuvoon on jo valmiiksi asennettu CSEasy vanteineen, myös asennus ja irrotus onnistuvat koko pyörää irrottamatta, jos kiinteä vanteen sarvi on sisäänpäin.

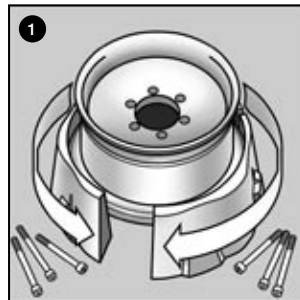

1 Aseta CSEasy-sovitin vanteen ympärille. Nosta vaakasuorassa olevaa vannetta kevyesti, jotta sovitin asettuu kiinnitysuran. Puristuslevy ei saa jäädä taitoksiin. Älä käytä työkaluja tässä työvaiheessa.

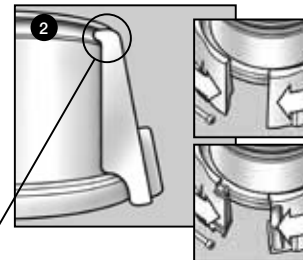

Huolehdi siitä, että ajoneuvo ei pääse asennuksen aikana

- liikkumaan eteen tai taakse
- kallistumaan

Ajoneuvon saa nostaa ainoastaan asianmukaisella ja painolle soveltuvalla nostimella. Renkas, sovitin ja vanne on puhdistettava ennen jokaista asennusta ja tarkistettava, että niissä ei ole vaurioita sekä tarvittaessa vaihdettava uusiin. Varmista työympäristön turvallisuus ja soveltuvuus asennukseen. Asennuksessa ei saa käyttää voitelu- tai liukuaineita. Osia ei saa esilämmittää eikä esijähdyttää.

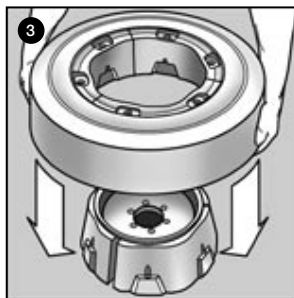

3 Aseta CSEasy-rengas vanteeseen kiinnitetyn sovitin päälle.

! Jos muoviosia käytetään uudelleen, on niiden kunto tarkastettava. Muoviosia, joihin merkitty viimeinen käyttöpäivämäärä on mennyt umpeen, ei saa käyttää uudelleen.

Ks. viimeinen käyttöpäivämäärä mm/yyyy

www.continental.fi
www.conti-online.com

Continental 

Hinnasto 2010

Osoite/address:
PL 2
02661 ESPOO

Puh./Tel
Vaihde (09) 3299 00
Tilaukset (09) 3299 0350

Fax
(09) 3299 0400
(09) 3299 0390 e-mail myynti@conti.de

Varasto:
Liukumäentie 15
00640 HELSINKI

Toimisto/office:
Hevosenkä 3
02600 ESPOO

www.continental.fi

Continental 