

Nuevas referencias en almacén





Por aplicación

07/2009



www.ate.de





| | | | | | | | |
|---|---|---|---|---|--------------|--|--|
|  |  |  |  |  | Denominación | Ref. OE correspondientes a las referencias ATE |  Referencia anterior / varios |
|---|---|---|---|---|--------------|--|--|

AUDI

| | | | | | | | | | |
|-------------------------|------------------|--|---------|---------|----------------|--------|----------------------|--------------------------------|--|
| A3 / A3 Sportback (03-) | 1,6 | | 05.2003 | | 03.2123-3223.3 | 010807 | CIL. MAESTRO TANDEM | 1K1 614 019 A | |
| | 1,6 FSI | | 08.2003 | | 03.2123-3223.3 | 010807 | CIL. MAESTRO TANDEM | 1K1 614 019 A | |
| | 1,9 TDI | | 06.2003 | | 03.2123-3223.3 | 010807 | CIL. MAESTRO TANDEM | 1K1 614 019 A | |
| | 2,0 FSI | | 05.2003 | | 03.2123-3223.3 | 010807 | CIL. MAESTRO TANDEM | 1K1 614 019 A | |
| | 2,0 TDI | | 05.2003 | | 03.2123-3223.3 | 010807 | CIL. MAESTRO TANDEM | 1K1 614 019 A | |
| | 2,0 TDI Quattro | | 05.2003 | | 03.2123-3223.3 | 010807 | CIL. MAESTRO TANDEM | 1K1 614 019 A | |
| | | | 08.2004 | | 03.2123-3223.3 | 010807 | CIL. MAESTRO TANDEM | 1K1 614 019 A | |
| | 2,0 TFSI | | 06.2004 | | 03.2123-3223.3 | 010807 | CIL. MAESTRO TANDEM | 1K1 614 019 A | |
| | 2,0 TFSI Quattro | | 06.2004 | | 03.2123-3223.3 | 010807 | CIL. MAESTRO TANDEM | 1K1 614 019 A | |
| | 3,2 Quattro | | 07.2003 | | 03.2123-3223.3 | 010807 | CIL. MAESTRO TANDEM | 1K1 614 019 A | |
| Q7 (06-) | 3,0 TDI | | 03.2006 | | 24.8190-0937.2 | 620937 | CONTACTO DE DESGASTE | 955 612 365 70 , 7L5 907 637 B | |
| | | | 10.2007 | | 24.8190-0937.2 | 620937 | CONTACTO DE DESGASTE | 955 612 365 70 , 7L5 907 637 B | |
| | | | 03.2006 | 10.2007 | 24.8190-0937.2 | 620937 | CONTACTO DE DESGASTE | 955 612 365 70 , 7L5 907 637 B | |
| | 3,6 FSI | | 08.2006 | | 24.8190-0937.2 | 620937 | CONTACTO DE DESGASTE | 955 612 365 70 , 7L5 907 637 B | |
| | 4,2 FSI | | 03.2006 | | 24.8190-0937.2 | 620937 | CONTACTO DE DESGASTE | 955 612 365 70 , 7L5 907 637 B | |
| | 4,2 TDI | | 03.2007 | | 24.8190-0937.2 | 620937 | CONTACTO DE DESGASTE | 955 612 365 70 , 7L5 907 637 B | |



| | | | | | | | |
|---|---|---|---|---|--------------|--|--|
|  |  |  |  |  | Denominación | Ref. OE correspondientes a las referencias ATE |  Referencia anterior / varios |
|---|---|---|---|---|--------------|--|--|

BMW

| | | | | | | | | | |
|----------------------------|--------|--|---------|--|----------------|--------|----------------|-----------------|--|
| 1er Reihe/E82 Coupe (07-) | 120 d | | 10.2007 | | 24.0120-0214.1 | 420214 | DISCO DE FRENO | 34 21 6 778 051 | |
| | 123 d | | 10.2007 | | 24.0120-0215.1 | 420215 | DISCO DE FRENO | 34 21 6 778 049 | |
| | 125 i | | 03.2008 | | 24.0120-0214.1 | 420214 | DISCO DE FRENO | 34 21 6 778 051 | |
| 1er Reihe/E88 Cabrio (08-) | 118 d | | 09.2008 | | 24.0120-0214.1 | 420214 | DISCO DE FRENO | 34 21 6 778 051 | |
| | 118 i | | 03.2008 | | 24.0120-0214.1 | 420214 | DISCO DE FRENO | 34 21 6 778 051 | |
| | 120 d | | 03.2008 | | 24.0120-0214.1 | 420214 | DISCO DE FRENO | 34 21 6 778 051 | |
| | 120 i | | 03.2008 | | 24.0120-0214.1 | 420214 | DISCO DE FRENO | 34 21 6 778 051 | |
| | 123 d | | 09.2008 | | 24.0120-0215.1 | 420215 | DISCO DE FRENO | 34 21 6 778 049 | |
| | 125 i | | 03.2008 | | 24.0120-0214.1 | 420214 | DISCO DE FRENO | 34 21 6 778 051 | |
| X5 (07-) | 3,0 d | | 01.2007 | | 24.0130-0199.1 | 430199 | DISCO DE FRENO | 34 11 6 771 986 | |
| | 3,0 si | | 01.2007 | | 24.0130-0200.1 | 430200 | DISCO DE FRENO | 34 11 6 771 985 | |
| | 4,8 i | | 01.2007 | | 24.0130-0199.1 | 430199 | DISCO DE FRENO | 34 11 6 771 986 | |
| X6 (08-) | 30 d | | 05.2008 | | 24.0130-0199.1 | 430199 | DISCO DE FRENO | 34 11 6 771 986 | |









| | | | | | | | | |
|--|--|--|--|--|--------------|--|--|------------------------------|
| | | | | | Denominación | Ref. OE correspondientes a las referencias ATE | | Referencia anterior / varios |
|--|--|--|--|--|--------------|--|--|------------------------------|

CITROEN

| | | | | | | | | | |
|-----------------------------|-----------------|--|---------|--|----------------|--------|---------------------|---------|--|
| C5 III Kombi (X7) (08-) | 1,6 HDi | | 02.2008 | | 03.2123-3123.3 | 010806 | CIL. MAESTRO TANDEM | 4601 P7 | |
| | 1,8 16V | | 02.2008 | | 03.2123-3123.3 | 010806 | CIL. MAESTRO TANDEM | 4601 P7 | |
| | 2,0 16V | | 02.2008 | | 03.2123-3123.3 | 010806 | CIL. MAESTRO TANDEM | 4601 P7 | |
| | 2,0 16V BioFlex | | 02.2008 | | 03.2123-3123.3 | 010806 | CIL. MAESTRO TANDEM | 4601 P7 | |
| | 2,0 HDi | | 02.2008 | | 03.2123-3123.3 | 010806 | CIL. MAESTRO TANDEM | 4601 P7 | |
| | 2,0 HDi 140 FAP | | 11.2008 | | 03.2123-3123.3 | 010806 | CIL. MAESTRO TANDEM | 4601 P7 | |
| | 2,2 HDi 170 | | 02.2008 | | 03.2123-3123.3 | 010806 | CIL. MAESTRO TANDEM | 4601 P7 | |
| | 2,7 HDi V6 | | 02.2008 | | 03.2123-3123.3 | 010806 | CIL. MAESTRO TANDEM | 4601 P7 | |
| | 3 | | 02.2008 | | 03.2123-3123.3 | 010806 | CIL. MAESTRO TANDEM | 4601 P7 | |
| | 3,0 V6 | | 02.2008 | | 03.2123-3123.3 | 010806 | CIL. MAESTRO TANDEM | 4601 P7 | |
| C5 III Limousine (X7) (08-) | 1,6 HDi | | 02.2008 | | 03.2123-3123.3 | 010806 | CIL. MAESTRO TANDEM | 4601 P7 | |
| | 1,8 i 16V | | 02.2008 | | 03.2123-3123.3 | 010806 | CIL. MAESTRO TANDEM | 4601 P7 | |
| | 2,0 16V BioFlex | | 02.2008 | | 03.2123-3123.3 | 010806 | CIL. MAESTRO TANDEM | 4601 P7 | |
| | 2,0 HDi | | 02.2008 | | 03.2123-3123.3 | 010806 | CIL. MAESTRO TANDEM | 4601 P7 | |
| | 2,0 HDi 140 FAP | | 11.2008 | | 03.2123-3123.3 | 010806 | CIL. MAESTRO TANDEM | 4601 P7 | |
| | 2,0 i 16V | | 02.2008 | | 03.2123-3123.3 | 010806 | CIL. MAESTRO TANDEM | 4601 P7 | |
| | 2,2 HDi 170 | | 02.2008 | | 03.2123-3123.3 | 010806 | CIL. MAESTRO TANDEM | 4601 P7 | |
| | 2,7 HDi | | 02.2008 | | 03.2123-3123.3 | 010806 | CIL. MAESTRO TANDEM | 4601 P7 | |
| | 3 | | 02.2008 | | 03.2123-3123.3 | 010806 | CIL. MAESTRO TANDEM | 4601 P7 | |



| | | | | | | | |
|---|---|---|---|---|---------------------|---|--|
|  |  |  |  |  | Denominación | Ref. OE correspondientes a las referencias ATE |  Referencia anterior / varios |
|---|---|---|---|---|---------------------|---|--|

CITROEN

| | | | | | | | | | |
|-----------------------------|--------------------|--|---------|--|----------------|--------|---------------------|--------------------------------|--|
| C5 III Limousine (X7) (08-) | 3,0 i V6 | | 02.2008 | | 03.2123-3123.3 | 010806 | CIL. MAESTRO TANDEM | 4601 P7 | |
| C6 (05-) | 2,2 HDi | | 06.2006 | | 03.2123-3123.3 | 010806 | CIL. MAESTRO TANDEM | 4601 P7 | |
| | 2,7 V6 HDi Biturbo | | 09.2005 | | 03.2123-3123.3 | 010806 | CIL. MAESTRO TANDEM | 4601 P7 | |
| | 3,0 V6 | | 09.2005 | | 03.2123-3123.3 | 010806 | CIL. MAESTRO TANDEM | 4601 P7 | |
| C8 (02-) | 2,0 16V | | 09.2005 | | 03.2122-2163.3 | 010800 | CIL. MAESTRO TANDEM | 4601 T0 | |
| | | | | | 03.2122-2163.3 | 010800 | CIL. MAESTRO TANDEM | 4601 T0 | |
| | 2,0 HDi | | | | 03.2122-2163.3 | 010800 | CIL. MAESTRO TANDEM | 4601 T0 | |
| | | | 02.2007 | | 03.2122-2163.3 | 010800 | CIL. MAESTRO TANDEM | 4601 T0 | |
| | | | 03.2006 | | 03.2122-2163.3 | 010800 | CIL. MAESTRO TANDEM | 4601 T0 | |
| | 2,2 16V | | | | 03.2122-2163.3 | 010800 | CIL. MAESTRO TANDEM | 4601 T0 | |
| | 2,2 HDi | | | | 03.2122-2163.3 | 010800 | CIL. MAESTRO TANDEM | 4601 T0 | |
| JUMPY (07-) | 1,6 HDi 90 | | 01.2007 | | 24.0114-0116.1 | 414116 | DISCO DE FRENO | 4249 23 , 4249 22 , 9467548487 | |
| | 2,0 HDi 120 | | 01.2007 | | 24.0114-0116.1 | 414116 | DISCO DE FRENO | 4249 23 , 4249 22 , 9467548487 | |
| | 2,0 HDi 140 | | 01.2007 | | 24.0114-0116.1 | 414116 | DISCO DE FRENO | 4249 23 , 4249 22 , 9467548487 | |
| | 2,0 i | | 01.2007 | | 24.0114-0116.1 | 414116 | DISCO DE FRENO | 4249 23 , 4249 22 , 9467548487 | |
| NEMO (08-) | 1,4 HDi | | 02.2008 | | 03.0137-0493.2 | 650493 | JUEGO DE ZAPATAS | 4241 N8 , 77364667 | |

Nuevas referencias en almacén - Por aplicación

07/2009



| | | | | | | | | |
|--|--|--|--|--|--------------|--|--|------------------------------|
| | | | | | Denominación | Ref. OE correspondientes a las referencias ATE | | Referencia anterior / varios |
|--|--|--|--|--|--------------|--|--|------------------------------|

DAIHATSU

| | | | | | | | | | |
|--------------|------------------|--|---------|--|----------------|--------|------------------|-----------------------------------|--|
| TREVIS (06-) | 1,0 i 12V (L651) | | 06.2006 | | 03.0137-0494.2 | 650494 | JUEGO DE ZAPATAS | 04495-B2220-000 , 04495-B2180-000 | |
|--------------|------------------|--|---------|--|----------------|--------|------------------|-----------------------------------|--|

FIAT

| | | | | | | | | | |
|--------------------|---------|--|---------|--|----------------|--------|------------------|--------------------------------|--|
| FIORINO (08-) | 1,3 JTD | | 02.2008 | | 03.0137-0493.2 | 650493 | JUEGO DE ZAPATAS | 4241 N8 , 77364667 | |
| FIORINO QUBO (08-) | | | 09.2008 | | 03.0137-0493.2 | 650493 | JUEGO DE ZAPATAS | 4241 N8 , 77364667 | |
| SCUDO (07-) | 1,6 JTD | | 01.2007 | | 24.0114-0116.1 | 414116 | DISCO DE FRENO | 4249 23 , 4249 22 , 9467548487 | |
| | 2,0 JTD | | 01.2007 | | 24.0114-0116.1 | 414116 | DISCO DE FRENO | 4249 23 , 4249 22 , 9467548487 | |

HONDA

| | | | | | | | | | |
|-------------------------|-----------------|--|---------|--|----------------|--------|--------------------|-------------------------------|------------|
| CIVIC (5-puertas) (06-) | 1,4 i 16V (FK1) | | 01.2006 | | 13.0460-5756.2 | 605756 | PASTILLAS DE FRENO | 45022-SMG-E01 , 45022-SMG-E00 | ver figura |
| | 1,8 i 16V (FK2) | | 01.2006 | | 13.0460-5756.2 | 605756 | PASTILLAS DE FRENO | 45022-SMG-E01 , 45022-SMG-E00 | ver figura |
| | 2,2 CTDi (FK3) | | 01.2006 | | 13.0460-5756.2 | 605756 | PASTILLAS DE FRENO | 45022-SMG-E01 , 45022-SMG-E00 | ver figura |
| CIVIC S (06-) | 1,8 VTEC (FN1) | | 09.2006 | | 13.0460-5756.2 | 605756 | PASTILLAS DE FRENO | 45022-SMG-E01 , 45022-SMG-E00 | ver figura |
| | 2,2 CTDi (FN3) | | 09.2006 | | 13.0460-5756.2 | 605756 | PASTILLAS DE FRENO | 45022-SMG-E01 , 45022-SMG-E00 | ver figura |



| | | | | | | | |
|--|----------|--|--|--|--------------|--|--|
| | i | | | | Denominación | Ref. OE correspondientes a las referencias ATE | i Referencia anterior / varios |
|--|----------|--|--|--|--------------|--|--|

HYUNDAI

| | | | | | | | | | |
|--------------|-----------|--|---------|--|----------------|--------|------------------|-------------|--|
| TUCSON (04-) | 2,0 CRDi | | 08.2004 | | 03.0137-3016.2 | 653016 | JUEGO DE ZAPATAS | 58350-2EA00 | |
| | | | 01.2006 | | 03.0137-3016.2 | 653016 | JUEGO DE ZAPATAS | 58350-2EA00 | |
| | 2,0 i 16V | | 08.2004 | | 03.0137-3016.2 | 653016 | JUEGO DE ZAPATAS | 58350-2EA00 | |

KIA

| | | | | | | | | | |
|----------------|-----------|--|---------|--|----------------|--------|------------------|-------------|--|
| SPORTAGE (04-) | 2,0 CRDi | | 01.2006 | | 03.0137-3016.2 | 653016 | JUEGO DE ZAPATAS | 58350-2EA00 | |
| | 2,0 i 16V | | 09.2004 | | 03.0137-3016.2 | 653016 | JUEGO DE ZAPATAS | 58350-2EA00 | |



| | | | | | | | | |
|--|--|--|--|--|--------------|--|--|------------------------------|
| | | | | | Denominación | Ref. OE correspondientes a las referencias ATE | | Referencia anterior / varios |
|--|--|--|--|--|--------------|--|--|------------------------------|

LANCIA

| | | | | | | | | | |
|---------------|-----------|----|---------|--|----------------|--------|--------------------|--------------------------------|------------|
| DELTA (08-) | 1,9 JTD | | 08.2008 | | 13.0460-7258.2 | 607258 | PASTILLAS DE FRENO | 77364929 | ver figura |
| | 2,0 JTD | | 08.2008 | | 13.0460-7258.2 | 607258 | PASTILLAS DE FRENO | 77364929 | ver figura |
| YPSILON (03-) | 1,2 i 16V | DI | 06.2003 | | 24.3541-1833.5 | 240403 | PINZA DE GARRA | 77363362 , 77364339 , 77362367 | |
| | | DD | 06.2003 | | 24.3541-1834.5 | 240404 | PINZA DE GARRA | 77363363 , 77364340 , 77362368 | |
| | 1,3 JTD | DD | 07.2007 | | 24.3541-1834.5 | 240404 | PINZA DE GARRA | 77363363 , 77364340 , 77362368 | |
| | | DD | 10.2006 | | 24.3541-1834.5 | 240404 | PINZA DE GARRA | 77363363 , 77364340 , 77362368 | |
| | | DD | 06.2003 | | 24.3541-1834.5 | 240404 | PINZA DE GARRA | 77363363 , 77364340 , 77362368 | |
| | | DI | 10.2006 | | 24.3541-1833.5 | 240403 | PINZA DE GARRA | 77363362 , 77364339 , 77362367 | |
| | | DI | 07.2007 | | 24.3541-1833.5 | 240403 | PINZA DE GARRA | 77363362 , 77364339 , 77362367 | |
| | | DI | 06.2003 | | 24.3541-1833.5 | 240403 | PINZA DE GARRA | 77363362 , 77364339 , 77362367 | |
| | 1,4 i 16V | DD | 06.2003 | | 24.3541-1834.5 | 240404 | PINZA DE GARRA | 77363363 , 77364340 , 77362368 | |
| | | DI | 06.2003 | | 24.3541-1833.5 | 240403 | PINZA DE GARRA | 77363362 , 77364339 , 77362367 | |



| | | | | | | |
|--|--|--|--|---------------------|---|----------------------------------|
| | | | | Denominación | Ref. OE correspondientes a las referencias ATE | Referencia anterior / varios |
|--|--|--|--|---------------------|---|----------------------------------|

LAND ROVER

| Modelo | Motor | Fecha | Referencia ATE | Referencia OE | Denominación | Referencia OE correspondientes a las referencias ATE | Referencia anterior / varios |
|----------------------------|-------------------|---------|----------------|---------------|--------------------|--|------------------------------|
| FREELANDER 2 (07-) | 2,2 TD4 | 01.2007 | 03.0137-3017.2 | 653017 | JUEGO DE ZAPATAS | LR001020 | |
| | 3,2 i6 | 01.2007 | 03.0137-3017.2 | 653017 | JUEGO DE ZAPATAS | LR001020 | |
| RANGE ROVER III (LM) (02-) | 4,2 | | 13.0460-4837.2 | 604837 | PASTILLAS DE FRENO | SFP500070 | ver figura |
| RANGE ROVER SPORT (05-) | 3,6 TD V8 | 04.2006 | 13.0460-4837.2 | 604837 | PASTILLAS DE FRENO | SFP500070 | ver figura |
| | 4,2 V8 Kompressor | 02.2005 | 13.0460-4837.2 | 604837 | PASTILLAS DE FRENO | SFP500070 | ver figura |



| | | | | | | | | |
|--|--|--|--|--|--------------|--|--|------------------------------|
| | | | | | Denominación | Ref. OE correspondientes a las referencias ATE | | Referencia anterior / varios |
|--|--|--|--|--|--------------|--|--|------------------------------|

MERCEDES BENZ

| | | | | | | | | | |
|------------------------------|----------------------|--|---------|--|----------------|--------|--------------------|---------------|------------|
| Clase C (S204) Break (07-) | C 180 Kompressor | | 09.2007 | | 13.0460-7244.2 | 607244 | PASTILLAS DE FRENO | 005 420 07 20 | ver figura |
| | C 200 CDI | | 09.2007 | | 13.0460-7244.2 | 607244 | PASTILLAS DE FRENO | 005 420 07 20 | ver figura |
| | C 200 Kompressor | | 09.2007 | | 13.0460-7244.2 | 607244 | PASTILLAS DE FRENO | 005 420 07 20 | ver figura |
| | C 220 CDI | | 09.2007 | | 13.0460-7244.2 | 607244 | PASTILLAS DE FRENO | 005 420 07 20 | ver figura |
| | C 230 | | 09.2007 | | 13.0460-7244.2 | 607244 | PASTILLAS DE FRENO | 005 420 07 20 | ver figura |
| | C 280 | | 09.2007 | | 13.0460-7244.2 | 607244 | PASTILLAS DE FRENO | 005 420 07 20 | ver figura |
| | C 320 CDI | | 09.2007 | | 13.0460-7244.2 | 607244 | PASTILLAS DE FRENO | 005 420 07 20 | ver figura |
| | C 320 CDI 4-Matic | | 09.2007 | | 13.0460-7244.2 | 607244 | PASTILLAS DE FRENO | 005 420 07 20 | ver figura |
| | C 350 | | 09.2007 | | 13.0460-7244.2 | 607244 | PASTILLAS DE FRENO | 005 420 07 20 | ver figura |
| Clase C (W204) Berlina (07-) | C 180 Kompressor | | 03.2007 | | 13.0460-7244.2 | 607244 | PASTILLAS DE FRENO | 005 420 07 20 | ver figura |
| | C 180 Kompressor Eco | | 01.2009 | | 13.0460-7244.2 | 607244 | PASTILLAS DE FRENO | 005 420 07 20 | ver figura |
| | C 200 CDI | | 03.2007 | | 13.0460-7244.2 | 607244 | PASTILLAS DE FRENO | 005 420 07 20 | ver figura |
| | C 200 Kompressor | | 03.2007 | | 13.0460-7244.2 | 607244 | PASTILLAS DE FRENO | 005 420 07 20 | ver figura |
| | C 220 CDI | | 03.2007 | | 13.0460-7244.2 | 607244 | PASTILLAS DE FRENO | 005 420 07 20 | ver figura |
| | C 230 | | 03.2007 | | 13.0460-7244.2 | 607244 | PASTILLAS DE FRENO | 005 420 07 20 | ver figura |
| | C 230 4-Matic | | 07.2007 | | 13.0460-7244.2 | 607244 | PASTILLAS DE FRENO | 005 420 07 20 | ver figura |
| | C 250 CDI | | 10.2008 | | 13.0460-7244.2 | 607244 | PASTILLAS DE FRENO | 005 420 07 20 | ver figura |
| | C 280 | | 03.2007 | | 13.0460-7244.2 | 607244 | PASTILLAS DE FRENO | 005 420 07 20 | ver figura |
| | C 280 4-Matic | | 07.2007 | | 13.0460-7244.2 | 607244 | PASTILLAS DE FRENO | 005 420 07 20 | ver figura |







| | | | | | | | | |
|--|--|--|--|--|--------------|--|--|------------------------------|
| | | | | | Denominación | Ref. OE correspondientes a las referencias ATE | | Referencia anterior / varios |
|--|--|--|--|--|--------------|--|--|------------------------------|

MERCEDES BENZ

| | | | | | | | | | |
|-------------------------------|-------------------|----|---------|---------|----------------|--------|---------------------|-------------------------------|------------|
| Clase C (W204) Berlina (07-) | C 320 CDI | | 03.2007 | | 13.0460-7244.2 | 607244 | PASTILLAS DE FRENO | 005 420 07 20 | ver figura |
| | C 320 CDI 4-Matic | | 07.2007 | | 13.0460-7244.2 | 607244 | PASTILLAS DE FRENO | 005 420 07 20 | ver figura |
| | C 350 | | 03.2007 | | 13.0460-7244.2 | 607244 | PASTILLAS DE FRENO | 005 420 07 20 | ver figura |
| | C 350 4 Matic | | 07.2007 | | 13.0460-7244.2 | 607244 | PASTILLAS DE FRENO | 005 420 07 20 | ver figura |
| | C 350 CGI | | 09.2008 | | 13.0460-7244.2 | 607244 | PASTILLAS DE FRENO | 005 420 07 20 | ver figura |
| Clase CL (C140) Coupé (96-99) | CL 420 | TD | 06.1996 | 02.1999 | 24.3727-0455.2 | 580455 | CABLE FRENO DE MANO | 140 420 10 85 , 140 420 20 85 | |
| | CL 500 | TD | 06.1996 | 02.1999 | 24.3727-0455.2 | 580455 | CABLE FRENO DE MANO | 140 420 10 85 , 140 420 20 85 | |
| | CL 600 | TD | 06.1996 | 02.1999 | 24.3727-0455.2 | 580455 | CABLE FRENO DE MANO | 140 420 10 85 , 140 420 20 85 | |
| Clase S (W140) (91-93) | 300 SE 2,8 | TD | 08.1992 | 06.1993 | 24.3727-0455.2 | 580455 | CABLE FRENO DE MANO | 140 420 10 85 , 140 420 20 85 | |
| | 300 SE 3,2 | TD | 04.1991 | 06.1993 | 24.3727-0455.2 | 580455 | CABLE FRENO DE MANO | 140 420 10 85 , 140 420 20 85 | |
| | 300 SEL 3,2 | TD | 04.1991 | 06.1993 | 24.3727-0455.2 | 580455 | CABLE FRENO DE MANO | 140 420 10 85 , 140 420 20 85 | |
| | 350 SD Turbo | TD | 03.1993 | 06.1993 | 24.3727-0455.2 | 580455 | CABLE FRENO DE MANO | 140 420 10 85 , 140 420 20 85 | |
| | 400 SE | TD | 04.1991 | 06.1993 | 24.3727-0455.2 | 580455 | CABLE FRENO DE MANO | 140 420 10 85 , 140 420 20 85 | |
| | 400 SEL | TD | 04.1991 | 06.1993 | 24.3727-0455.2 | 580455 | CABLE FRENO DE MANO | 140 420 10 85 , 140 420 20 85 | |
| | 500 SE | TD | 04.1991 | 06.1993 | 24.3727-0455.2 | 580455 | CABLE FRENO DE MANO | 140 420 10 85 , 140 420 20 85 | |







| | | | | | | | |
|---|---|---|---|---|---------------------|---|---|
|  |  |  |  |  | Denominación | Ref. OE correspondientes a las referencias ATE |  Referencia anterior / varios |
|---|---|---|---|---|---------------------|---|---|

MERCEDES BENZ

| Clase S (W140) (91-93) | 500 SEC | TD | 06.1992 | 06.1993 | 24.3727-0455.2 | 580455 | CABLE FRENO DE MANO | 140 420 10 85 , 140 420 20 85 | |
|------------------------|-------------|----|---------|---------|----------------|--------|---------------------|-------------------------------|--|
| | 500 SEL | TD | 04.1991 | 06.1993 | 24.3727-0455.2 | 580455 | CABLE FRENO DE MANO | 140 420 10 85 , 140 420 20 85 | |
| | 600 SE V12 | TD | 04.1991 | 06.1993 | 24.3727-0455.2 | 580455 | CABLE FRENO DE MANO | 140 420 10 85 , 140 420 20 85 | |
| | 600 SEC V12 | TD | 06.1992 | 06.1993 | 24.3727-0455.2 | 580455 | CABLE FRENO DE MANO | 140 420 10 85 , 140 420 20 85 | |
| | 600 SEL V12 | TD | 04.1991 | 06.1993 | 24.3727-0455.2 | 580455 | CABLE FRENO DE MANO | 140 420 10 85 , 140 420 20 85 | |
| Clase S (W140) (93-98) | S 280 | TD | 07.1993 | 10.1998 | 24.3727-0455.2 | 580455 | CABLE FRENO DE MANO | 140 420 10 85 , 140 420 20 85 | |
| | S 300 TD | TD | 04.1996 | 10.1998 | 24.3727-0455.2 | 580455 | CABLE FRENO DE MANO | 140 420 10 85 , 140 420 20 85 | |
| | S 320 | TD | 07.1993 | 10.1998 | 24.3727-0455.2 | 580455 | CABLE FRENO DE MANO | 140 420 10 85 , 140 420 20 85 | |
| | S 350 TD | TD | 07.1993 | 06.1996 | 24.3727-0455.2 | 580455 | CABLE FRENO DE MANO | 140 420 10 85 , 140 420 20 85 | |
| | S 420 | TD | 07.1993 | 10.1998 | 24.3727-0455.2 | 580455 | CABLE FRENO DE MANO | 140 420 10 85 , 140 420 20 85 | |
| | S 420 C | TD | 04.1994 | 05.1996 | 24.3727-0455.2 | 580455 | CABLE FRENO DE MANO | 140 420 10 85 , 140 420 20 85 | |
| | S 500 | TD | 07.1993 | 10.1998 | 24.3727-0455.2 | 580455 | CABLE FRENO DE MANO | 140 420 10 85 , 140 420 20 85 | |
| | S 500 C | TD | 07.1993 | 05.1996 | 24.3727-0455.2 | 580455 | CABLE FRENO DE MANO | 140 420 10 85 , 140 420 20 85 | |



| | | | | | | | |
|---|---|---|---|---|---------------------|---|---|
|  |  |  |  |  | Denominación | Ref. OE correspondientes a las referencias ATE |  Referencia anterior / varios |
|---|---|---|---|---|---------------------|---|---|

MERCEDES BENZ

| | | | | | | | | | |
|---------------------------------------|----------|----|---------|---------|----------------|--------|----------------------|-------------------------------|--|
| Clase S (W140) (93-98) | S 600 | TD | 07.1993 | 10.1998 | 24.3727-0455.2 | 580455 | CABLE FRENO DE MANO | 140 420 10 85 , 140 420 20 85 | |
| | S 600 C | TD | 07.1993 | 05.1996 | 24.3727-0455.2 | 580455 | CABLE FRENO DE MANO | 140 420 10 85 , 140 420 20 85 | |
| Transporter (BM 631) MB 100 D (87-96) | MB 100 D | | 09.1987 | 02.1996 | 24.6513-1712.3 | 320282 | CORRECTOR DE FRENADO | 631 430 11 81 | |





| | | | | | | | | |
|--|--|--|--|--|--------------|--|--|------------------------------|
| | | | | | Denominación | Ref. OE correspondientes a las referencias ATE | | Referencia anterior / varios |
|--|--|--|--|--|--------------|--|--|------------------------------|

NISSAN

| | | | | | | | | | |
|-------------------------|-----------|----|---------|---------|----------------|--------|---------------------|-----------------------------|--|
| ALMERA (N16) (00-06) | 1,5 dCi | DI | 01.2003 | 11.2006 | 24.5266-0453.3 | 330931 | LATIGUILLO | 46210-5M405 | |
| | 1,5 i | DI | 10.2002 | 11.2006 | 24.5266-0453.3 | 330931 | LATIGUILLO | 46210-5M405 | |
| | | DI | 02.2000 | 11.2006 | 24.5266-0453.3 | 330931 | LATIGUILLO | 46210-5M405 | |
| | 1,8 i | DI | 02.2000 | 11.2006 | 24.5266-0453.3 | 330931 | LATIGUILLO | 46210-5M405 | |
| | | DI | 10.2002 | 11.2006 | 24.5266-0453.3 | 330931 | LATIGUILLO | 46210-5M405 | |
| | 2,2 dCi | DI | 09.2003 | 11.2006 | 24.5266-0453.3 | 330931 | LATIGUILLO | 46210-5M405 | |
| | 2,2 Di | DI | 02.2000 | 11.2006 | 24.5266-0453.3 | 330931 | LATIGUILLO | 46210-5M405 | |
| MICRA (K12E) (03-) | 1,0 i 16V | | 01.2003 | | 03.2123-2923.3 | 010791 | CIL. MAESTRO TANDEM | 77 01 208 402 , 46010-AX720 | |
| | 1,2 i 16V | | 01.2003 | | 03.2123-2923.3 | 010791 | CIL. MAESTRO TANDEM | 77 01 208 402 , 46010-AX720 | |
| | 1,4 i 16V | | 01.2003 | | 03.2123-2923.3 | 010791 | CIL. MAESTRO TANDEM | 77 01 208 402 , 46010-AX720 | |
| | 1,5 dCi | | 09.2003 | | 03.2123-2923.3 | 010791 | CIL. MAESTRO TANDEM | 77 01 208 402 , 46010-AX720 | |
| | | | 01.2003 | | 03.2123-2923.3 | 010791 | CIL. MAESTRO TANDEM | 77 01 208 402 , 46010-AX720 | |
| | 1,6 i 16V | | 05.2005 | | 03.2123-2923.3 | 010791 | CIL. MAESTRO TANDEM | 77 01 208 402 , 46010-AX720 | |
| MICRA C+C (CK12E) (05-) | 1,4 i 16V | | 08.2005 | | 03.2123-2923.3 | 010791 | CIL. MAESTRO TANDEM | 77 01 208 402 , 46010-AX720 | |
| | 1,6 i 16V | | 08.2005 | | 03.2123-2923.3 | 010791 | CIL. MAESTRO TANDEM | 77 01 208 402 , 46010-AX720 | |
| NOTE (E11E) (06-) | 1,4 | | 03.2006 | | 03.2123-2923.3 | 010791 | CIL. MAESTRO TANDEM | 77 01 208 402 , 46010-AX720 | |
| | 1,5 dCi | | 03.2006 | | 03.2123-2923.3 | 010791 | CIL. MAESTRO TANDEM | 77 01 208 402 , 46010-AX720 | |
| | | | 12.2007 | | 03.2123-2923.3 | 010791 | CIL. MAESTRO TANDEM | 77 01 208 402 , 46010-AX720 | |
| | 1,6 | | 03.2006 | | 03.2123-2923.3 | 010791 | CIL. MAESTRO TANDEM | 77 01 208 402 , 46010-AX720 | |



| | | | | | | | |
|---|----------|---|---|---|---------------------|---|--|
|  | i |  |  |  | Denominación | Ref. OE correspondientes a las referencias ATE | i Referencia anterior / varios |
|---|----------|---|---|---|---------------------|---|--|

OPEL

| | | | | | | | | | |
|-------------|----------|--|---------|--|----------------|--------|----------------|------------------------------------|--|
| AGILA (08-) | 1 | | 01.2008 | | 24.0120-0211.1 | 420211 | DISCO DE FRENO | 47 08 241 , 93192978 , 55311-62J00 | |
| | 1,2 | | 01.2008 | | 24.0120-0211.1 | 420211 | DISCO DE FRENO | 47 08 241 , 93192978 , 55311-62J00 | |
| | 1,3 CDTI | | 01.2008 | | 24.0120-0211.1 | 420211 | DISCO DE FRENO | 47 08 241 , 93192978 , 55311-62J00 | |



| | | | | | | | | |
|--|--|--|--|--|--------------|--|--|------------------------------|
| | | | | | Denominación | Ref. OE correspondientes a las referencias ATE | | Referencia anterior / varios |
|--|--|--|--|--|--------------|--|--|------------------------------|

PEUGEOT

| | | | | | | | | | |
|-------------------|----------------|--|---------|--|----------------|--------|---------------------|---------|--|
| 207 Berlina (06-) | 1,4 | | 02.2006 | | 03.0520-9420.3 | 699420 | ATE TOPKIT | 4242 20 | |
| | | | 09.2007 | | 03.0520-9420.3 | 699420 | ATE TOPKIT | 4242 20 | |
| | 1,4 16V | | 02.2006 | | 03.0520-9420.3 | 699420 | ATE TOPKIT | 4242 20 | |
| | 1,4 16V VTi | | 08.2007 | | 03.0520-9420.3 | 699420 | ATE TOPKIT | 4242 20 | |
| | 1,4 HDi | | 02.2006 | | 03.0520-9420.3 | 699420 | ATE TOPKIT | 4242 20 | |
| | 1,6 HDi 90 | | 02.2006 | | 03.0520-9420.3 | 699420 | ATE TOPKIT | 4242 20 | |
| 207 SW (07-) | 1,4 i | | 06.2007 | | 03.0520-9420.3 | 699420 | ATE TOPKIT | 4242 20 | |
| | 1,4 i 16V | | 06.2007 | | 03.0520-9420.3 | 699420 | ATE TOPKIT | 4242 20 | |
| | 1,6 HDi FAP 90 | | 06.2007 | | 03.0520-9420.3 | 699420 | ATE TOPKIT | 4242 20 | |
| 407 Coupé (05-) | 2,0 HDi | | 07.2007 | | 03.2122-2023.3 | 010798 | CIL. MAESTRO TANDEM | 4601 P6 | |
| | | | 07.2007 | | 03.2123-3123.3 | 010806 | CIL. MAESTRO TANDEM | 4601 P7 | |
| | 2,2 16V | | 10.2005 | | 03.2123-3123.3 | 010806 | CIL. MAESTRO TANDEM | 4601 P7 | |
| | 2,7 HDi | | 10.2005 | | 03.2123-3123.3 | 010806 | CIL. MAESTRO TANDEM | 4601 P7 | |
| | 3,0 V6 | | 10.2005 | | 03.2123-3123.3 | 010806 | CIL. MAESTRO TANDEM | 4601 P7 | |
| 407 Berlina (04-) | 1,6 HDi 110 | | 05.2004 | | 03.2122-2023.3 | 010798 | CIL. MAESTRO TANDEM | 4601 P6 | |
| | 1,8 16V | | 09.2005 | | 03.2122-2023.3 | 010798 | CIL. MAESTRO TANDEM | 4601 P6 | |
| | | | 05.2004 | | 03.2122-2023.3 | 010798 | CIL. MAESTRO TANDEM | 4601 P6 | |
| | 2,0 16V | | 05.2004 | | 03.2122-2023.3 | 010798 | CIL. MAESTRO TANDEM | 4601 P6 | |
| | | | 09.2005 | | 03.2122-2023.3 | 010798 | CIL. MAESTRO TANDEM | 4601 P6 | |

Nuevas referencias en almacén - Por aplicación

07/2009



| | | | | | | | |
|--|--|--|--|--------------|--|--|------------------------------|
| | | | | Denominación | Ref. OE correspondientes a las referencias ATE | | Referencia anterior / varios |
|--|--|--|--|--------------|--|--|------------------------------|

PEUGEOT

| | | | | | | | | | |
|-------------------|-------------|--|---------|--|----------------|--------|---------------------|---------|--|
| 407 Berlina (04-) | 2,0 HDi 135 | | 05.2004 | | 03.2122-2023.3 | 010798 | CIL. MAESTRO TANDEM | 4601 P6 | |
| | 2,2 16V | | 09.2005 | | 03.2123-3123.3 | 010806 | CIL. MAESTRO TANDEM | 4601 P7 | |
| | | | 05.2004 | | 03.2123-3123.3 | 010806 | CIL. MAESTRO TANDEM | 4601 P7 | |
| | 2,2 HDi 170 | | 05.2006 | | 03.2123-3123.3 | 010806 | CIL. MAESTRO TANDEM | 4601 P7 | |
| | 2,7 HDi | | 10.2005 | | 03.2123-3123.3 | 010806 | CIL. MAESTRO TANDEM | 4601 P7 | |
| | 3,0 V6 | | 05.2004 | | 03.2123-3123.3 | 010806 | CIL. MAESTRO TANDEM | 4601 P7 | |
| 407 SW (04-) | 1,6 HDi 110 | | 05.2004 | | 03.2122-2023.3 | 010798 | CIL. MAESTRO TANDEM | 4601 P6 | |
| | 1,8 16V | | 05.2004 | | 03.2122-2023.3 | 010798 | CIL. MAESTRO TANDEM | 4601 P6 | |
| | | | 09.2005 | | 03.2122-2023.3 | 010798 | CIL. MAESTRO TANDEM | 4601 P6 | |
| | 2,0 16V | | 05.2004 | | 03.2122-2023.3 | 010798 | CIL. MAESTRO TANDEM | 4601 P6 | |
| | | | 09.2005 | | 03.2122-2023.3 | 010798 | CIL. MAESTRO TANDEM | 4601 P6 | |
| | 2,0 BioFlex | | 01.2008 | | 03.2122-2023.3 | 010798 | CIL. MAESTRO TANDEM | 4601 P6 | |
| | 2,0 HDi 135 | | 05.2004 | | 03.2122-2023.3 | 010798 | CIL. MAESTRO TANDEM | 4601 P6 | |
| | 2,0 HDi 140 | | 08.2008 | | 03.2122-2023.3 | 010798 | CIL. MAESTRO TANDEM | 4601 P6 | |
| | 2,2 16V | | 09.2005 | | 03.2123-3123.3 | 010806 | CIL. MAESTRO TANDEM | 4601 P7 | |
| | | | 05.2004 | | 03.2123-3123.3 | 010806 | CIL. MAESTRO TANDEM | 4601 P7 | |
| | 2,2 HDi 170 | | 05.2006 | | 03.2123-3123.3 | 010806 | CIL. MAESTRO TANDEM | 4601 P7 | |
| | 2,7 HDi | | 10.2005 | | 03.2123-3123.3 | 010806 | CIL. MAESTRO TANDEM | 4601 P7 | |
| | 3,0 V6 | | 05.2004 | | 03.2123-3123.3 | 010806 | CIL. MAESTRO TANDEM | 4601 P7 | |



| | | | | | | | | |
|--|--|--|--|--|--------------|--|--|------------------------------|
| | | | | | Denominación | Ref. OE correspondientes a las referencias ATE | | Referencia anterior / varios |
|--|--|--|--|--|--------------|--|--|------------------------------|

PEUGEOT

| | | | | | | | | | |
|--------------------|-------------|--|---------|---------|----------------|--------|---------------------|--------------------------------|--|
| 807 (02-) | 2,0 16V | | 09.2005 | | 03.2122-2163.3 | 010800 | CIL. MAESTRO TANDEM | 4601 T0 | |
| | | | | | 03.2122-2163.3 | 010800 | CIL. MAESTRO TANDEM | 4601 T0 | |
| | 2,0 HDi | | 06.2006 | | 03.2122-2163.3 | 010800 | CIL. MAESTRO TANDEM | 4601 T0 | |
| | | | | 05.2006 | 03.2122-2163.3 | 010800 | CIL. MAESTRO TANDEM | 4601 T0 | |
| | | | | | 03.2122-2163.3 | 010800 | CIL. MAESTRO TANDEM | 4601 T0 | |
| | 2,2 16V | | | | 03.2122-2163.3 | 010800 | CIL. MAESTRO TANDEM | 4601 T0 | |
| | 2,2 HDi | | | | 03.2122-2163.3 | 010800 | CIL. MAESTRO TANDEM | 4601 T0 | |
| BIPPER (08-) | 1,4 HDi | | 02.2008 | | 03.0137-0493.2 | 650493 | JUEGO DE ZAPATAS | 4241 N8 , 77364667 | |
| EXPERT Tepee (07-) | 1,6 HDi 90 | | 01.2007 | | 24.0114-0116.1 | 414116 | DISCO DE FRENO | 4249 23 , 4249 22 , 9467548487 | |
| | 2,0 HDi 120 | | 01.2007 | | 24.0114-0116.1 | 414116 | DISCO DE FRENO | 4249 23 , 4249 22 , 9467548487 | |
| | 2,0 HDi 140 | | 01.2007 | | 24.0114-0116.1 | 414116 | DISCO DE FRENO | 4249 23 , 4249 22 , 9467548487 | |
| | 2,0 i | | 01.2007 | | 24.0114-0116.1 | 414116 | DISCO DE FRENO | 4249 23 , 4249 22 , 9467548487 | |



| | | | | | | | | |
|--|--|--|--|--|--------------|--|--|------------------------------|
| | | | | | Denominación | Ref. OE correspondientes a las referencias ATE | | Referencia anterior / varios |
|--|--|--|--|--|--------------|--|--|------------------------------|

PORSCHE

| | | | | | | | | | |
|-----------------------|-----------|----|---------|---------|----------------|--------|----------------------|--------------------------------|------------|
| BOXSTER (986) (96-04) | 2,5 | | 09.1996 | 07.1999 | 13.0460-4814.2 | 604814 | PASTILLAS DE FRENO | | ver figura |
| | 2,7 | | 08.1999 | 06.2002 | 13.0460-4814.2 | 604814 | PASTILLAS DE FRENO | | ver figura |
| | | | 07.2002 | 12.2004 | 13.0460-4814.2 | 604814 | PASTILLAS DE FRENO | | ver figura |
| BOXSTER (987) (05-) | | | 11.2004 | 07.2006 | 24.0120-0212.1 | 420212 | DISCO DE FRENO | 987 352 401 01 | |
| | | | 06.2006 | | 24.0120-0212.1 | 420212 | DISCO DE FRENO | 987 352 401 01 | |
| | | DI | 11.2004 | 07.2006 | 24.0124-0211.1 | 424211 | DISCO DE FRENO | 987 351 401 01 | |
| | | DI | 06.2006 | | 24.0124-0211.1 | 424211 | DISCO DE FRENO | 987 351 401 01 | |
| | | DD | 06.2006 | | 24.0124-0210.1 | 424210 | DISCO DE FRENO | 987 351 402 01 | |
| | | DD | 11.2004 | 07.2006 | 24.0124-0210.1 | 424210 | DISCO DE FRENO | 987 351 402 01 | |
| | 2,9 | | 01.2009 | | 24.0120-0212.1 | 420212 | DISCO DE FRENO | 987 352 401 01 | |
| CAYENNE (03-) | 3,6 | | 01.2007 | | 24.8190-0937.2 | 620937 | CONTACTO DE DESGASTE | 955 612 365 70 , 7L5 907 637 B | |
| | 4,8 S | | 01.2007 | | 24.8190-0937.2 | 620937 | CONTACTO DE DESGASTE | 955 612 365 70 , 7L5 907 637 B | |
| | 4,8 Turbo | | 01.2007 | | 24.8190-0937.2 | 620937 | CONTACTO DE DESGASTE | 955 612 365 70 , 7L5 907 637 B | |
| CAYMAN (987C) (05-) | 2,7 | | 05.2006 | | 24.0120-0212.1 | 420212 | DISCO DE FRENO | 987 352 401 01 | |
| | | DI | 05.2006 | | 24.0124-0211.1 | 424211 | DISCO DE FRENO | 987 351 401 01 | |
| | | DD | 05.2006 | | 24.0124-0210.1 | 424210 | DISCO DE FRENO | 987 351 402 01 | |
| | 2,9 | | 01.2009 | | 24.0120-0212.1 | 420212 | DISCO DE FRENO | 987 352 401 01 | |



| | | | | | | | | |
|--|--|--|--|--|--------------|--|--|------------------------------|
| | | | | | Denominación | Ref. OE correspondientes a las referencias ATE | | Referencia anterior / varios |
|--|--|--|--|--|--------------|--|--|------------------------------|

RENAULT

| | | | | | | | | | |
|--------------------------|-----------------|--|---------|---------|----------------|--------|---------------------|-------------------------------|--|
| AVANTIME (01-03) | 2,0 16V Turbo | | 11.2001 | 06.2003 | 13.0460-0077.2 | 610077 | ACCESORIO PASTILLAS | | |
| | 2,2 dCi | | 05.2002 | 06.2003 | 13.0460-0077.2 | 610077 | ACCESORIO PASTILLAS | | |
| | 3,0 V6 | | 09.2001 | 06.2003 | 13.0460-0077.2 | 610077 | ACCESORIO PASTILLAS | | |
| CLIO III (BR_/CR_) (05-) | 1,2 | | 10.2005 | | 24.5111-0455.3 | 330914 | LATIGUILLO | 82 00 129 954 , 82 00 597 210 | |
| | | | 09.2006 | | 24.5111-0455.3 | 330914 | LATIGUILLO | 82 00 129 954 , 82 00 597 210 | |
| | 1,2 16V | | 06.2005 | | 24.5111-0455.3 | 330914 | LATIGUILLO | 82 00 129 954 , 82 00 597 210 | |
| | 1,2 16V Hi-Flex | | 07.2008 | | 24.5111-0455.3 | 330914 | LATIGUILLO | 82 00 129 954 , 82 00 597 210 | |
| | 1,4 16V | | 06.2005 | | 24.5111-0455.3 | 330914 | LATIGUILLO | 82 00 129 954 , 82 00 597 210 | |
| | 1,5 D | | 11.2007 | | 24.5111-0455.3 | 330914 | LATIGUILLO | 82 00 129 954 , 82 00 597 210 | |
| | 1,5 dCi | | 05.2005 | 10.2006 | 24.5111-0455.3 | 330914 | LATIGUILLO | 82 00 129 954 , 82 00 597 210 | |
| | | | 06.2005 | | 24.5111-0455.3 | 330914 | LATIGUILLO | 82 00 129 954 , 82 00 597 210 | |
| | 1,6 16V | | 06.2005 | | 24.5111-0455.3 | 330914 | LATIGUILLO | 82 00 129 954 , 82 00 597 210 | |
| CLIO III Grandtour (08-) | 1,2 16V | | 02.2008 | | 24.5111-0455.3 | 330914 | LATIGUILLO | 82 00 129 954 , 82 00 597 210 | |
| | 1,2 16V Hi-Flex | | 07.2008 | | 24.5111-0455.3 | 330914 | LATIGUILLO | 82 00 129 954 , 82 00 597 210 | |







| | | | | | | | | |
|--|--|--|--|--|--------------|--|--|------------------------------|
| | | | | | Denominación | Ref. OE correspondientes a las referencias ATE | | Referencia anterior / varios |
|--|--|--|--|--|--------------|--|--|------------------------------|

RENAULT

| | | | | | | | | | |
|--------------------------------------|---------------|--|---------|---------|----------------|--------|-----------------------|-------------------------------|--|
| CLIO III Grandtour (08-) | 1,5 dCi | | 02.2008 | | 24.5111-0455.3 | 330914 | LATIGUILLO | 82 00 129 954 , 82 00 597 210 | |
| | 1,6 16V | | 02.2008 | | 24.5111-0455.3 | 330914 | LATIGUILLO | 82 00 129 954 , 82 00 597 210 | |
| GRAND SCENIC (04-09) | 1,5 dCi | | 08.2007 | 03.2009 | 24.0111-0148.2 | 411148 | DISCO C/ROD. Y SENSOR | 77 01 208 230 | |
| | | | 03.2008 | 03.2009 | 24.0111-0148.2 | 411148 | DISCO C/ROD. Y SENSOR | 77 01 208 230 | |
| | | | 04.2004 | 03.2009 | 24.0111-0148.2 | 411148 | DISCO C/ROD. Y SENSOR | 77 01 208 230 | |
| | 1,6 | | 04.2004 | 03.2009 | 24.0111-0148.2 | 411148 | DISCO C/ROD. Y SENSOR | 77 01 208 230 | |
| | | | 06.2006 | 03.2009 | 24.0111-0148.2 | 411148 | DISCO C/ROD. Y SENSOR | 77 01 208 230 | |
| | | | 07.2006 | 03.2009 | 24.0111-0148.2 | 411148 | DISCO C/ROD. Y SENSOR | 77 01 208 230 | |
| | 1,9 dCi | | 04.2004 | 03.2009 | 24.0111-0148.2 | 411148 | DISCO C/ROD. Y SENSOR | 77 01 208 230 | |
| | | | 05.2005 | 03.2009 | 24.0111-0148.2 | 411148 | DISCO C/ROD. Y SENSOR | 77 01 208 230 | |
| | 2,0 16V | | 04.2004 | 03.2009 | 24.0111-0148.2 | 411148 | DISCO C/ROD. Y SENSOR | 77 01 208 230 | |
| | 2,0 16V Turbo | | 04.2004 | 03.2009 | 24.0111-0148.2 | 411148 | DISCO C/ROD. Y SENSOR | 77 01 208 230 | |
| MEGANE II Coupé/Cabriole (EM_) (03-) | 1,5 dCi | | 05.2005 | | 13.0460-0077.2 | 610077 | ACCESORIO PASTILLAS | | |
| | 1,6 16V | | 09.2003 | | 13.0460-0077.2 | 610077 | ACCESORIO PASTILLAS | | |
| | 1,9 dCi | | 09.2003 | | 13.0460-0077.2 | 610077 | ACCESORIO PASTILLAS | | |
| | 2,0 16V | | 09.2003 | | 13.0460-0077.2 | 610077 | ACCESORIO PASTILLAS | | |
| | 2,0 16V Turbo | | 05.2004 | | 13.0460-0077.2 | 610077 | ACCESORIO PASTILLAS | | |
| | 2,0 dCi | | 09.2005 | | 13.0460-0077.2 | 610077 | ACCESORIO PASTILLAS | | |
| MEGANE II Grandtour (KM_) (03-) | 1,4 16V | | 09.2003 | | 13.0460-0077.2 | 610077 | ACCESORIO PASTILLAS | | |







| | | | | | | | |
|---|---|---|---|---|---------------------|---|--|
|  |  |  |  |  | Denominación | Ref. OE correspondientes a las referencias ATE |  Referencia anterior / varios |
|---|---|---|---|---|---------------------|---|--|

RENAULT

| | | | | | | | | |
|---|---------------|--|---------|--|----------------|--------|---------------------|--|
| MEGANE II Grandtour (KM_) (03-) | 1,5 dCi | | 02.2004 | | 13.0460-0077.2 | 610077 | ACCESORIO PASTILLAS | |
| | | | 09.2003 | | 13.0460-0077.2 | 610077 | ACCESORIO PASTILLAS | |
| | 1,6 | | 09.2003 | | 13.0460-0077.2 | 610077 | ACCESORIO PASTILLAS | |
| | 1,6 FlexFuel | | 02.2008 | | 13.0460-0077.2 | 610077 | ACCESORIO PASTILLAS | |
| | 1,9 dCi | | 09.2003 | | 13.0460-0077.2 | 610077 | ACCESORIO PASTILLAS | |
| | 2,0 16V | | 09.2003 | | 13.0460-0077.2 | 610077 | ACCESORIO PASTILLAS | |
| | 2,0 dCi | | 09.2005 | | 13.0460-0077.2 | 610077 | ACCESORIO PASTILLAS | |
| MEGANE II Berlina 3/5-puertas (BM_/CM_) (02-) | 1,4 16V | | 11.2002 | | 13.0460-0077.2 | 610077 | ACCESORIO PASTILLAS | |
| | 1,5 dCi | | 11.2008 | | 13.0460-0077.2 | 610077 | ACCESORIO PASTILLAS | |
| | | | 01.2007 | | 13.0460-0077.2 | 610077 | ACCESORIO PASTILLAS | |
| | | | 11.2002 | | 13.0460-0077.2 | 610077 | ACCESORIO PASTILLAS | |
| | 1,6 16V | | 11.2008 | | 13.0460-0077.2 | 610077 | ACCESORIO PASTILLAS | |
| | | | 11.2002 | | 13.0460-0077.2 | 610077 | ACCESORIO PASTILLAS | |
| | 1,6 FlexFuel | | 01.2007 | | 13.0460-0077.2 | 610077 | ACCESORIO PASTILLAS | |
| | 1,9 dCi | | 05.2005 | | 13.0460-0077.2 | 610077 | ACCESORIO PASTILLAS | |
| | | | 11.2002 | | 13.0460-0077.2 | 610077 | ACCESORIO PASTILLAS | |
| | 2 | | 08.2006 | | 13.0460-0077.2 | 610077 | ACCESORIO PASTILLAS | |
| | 2,0 16V | | 11.2002 | | 13.0460-0077.2 | 610077 | ACCESORIO PASTILLAS | |
| | 2,0 16V Turbo | | 05.2004 | | 13.0460-0077.2 | 610077 | ACCESORIO PASTILLAS | |
| | 2,0 dCi | | 09.2005 | | 13.0460-0077.2 | 610077 | ACCESORIO PASTILLAS | |
| | 2,0 Sport | | 05.2004 | | 13.0460-0077.2 | 610077 | ACCESORIO PASTILLAS | |



| | | | | | | | |
|---|---|---|---|---|--------------|--|--|
|  |  |  |  |  | Denominación | Ref. OE correspondientes a las referencias ATE |  Referencia anterior / varios |
|---|---|---|---|---|--------------|--|--|

RENAULT

| | | | | | | | | |
|---|-----------------|--|---------|--|----------------|--------|---------------------|-------------------------------|
| MEGANE II Berlina 4-puertas (LM_) (03-) | 1,4 16V | | 09.2003 | | 13.0460-0077.2 | 610077 | ACCESORIO PASTILLAS | |
| | 1,5 dCi | | 09.2003 | | 13.0460-0077.2 | 610077 | ACCESORIO PASTILLAS | |
| | | | 11.2008 | | 13.0460-0077.2 | 610077 | ACCESORIO PASTILLAS | |
| | 1,6 | | 05.2005 | | 13.0460-0077.2 | 610077 | ACCESORIO PASTILLAS | |
| | | | 09.2003 | | 13.0460-0077.2 | 610077 | ACCESORIO PASTILLAS | |
| | 1,6 16V | | 09.2003 | | 13.0460-0077.2 | 610077 | ACCESORIO PASTILLAS | |
| | | | 11.2008 | | 13.0460-0077.2 | 610077 | ACCESORIO PASTILLAS | |
| | 1,9 dCi | | 09.2003 | | 13.0460-0077.2 | 610077 | ACCESORIO PASTILLAS | |
| | 2,0 16V | | 09.2003 | | 13.0460-0077.2 | 610077 | ACCESORIO PASTILLAS | |
| MODUS/GRAND MODUS (04-) | 1,2 16V | | 05.2007 | | 24.5111-0455.3 | 330914 | LATIGUILLO | 82 00 129 954 , 82 00 597 210 |
| | | | 08.2004 | | 24.5111-0455.3 | 330914 | LATIGUILLO | 82 00 129 954 , 82 00 597 210 |
| | | | 08.2004 | | 03.2123-2923.3 | 010791 | CIL. MAESTRO TANDEM | 77 01 208 402 , 46010-AX720 |
| | | | 05.2007 | | 03.2123-2923.3 | 010791 | CIL. MAESTRO TANDEM | 77 01 208 402 , 46010-AX720 |
| | 1,2 16V Hi-Flex | | 10.2008 | | 24.5111-0455.3 | 330914 | LATIGUILLO | 82 00 129 954 , 82 00 597 210 |
| | | | 10.2008 | | 03.2123-2923.3 | 010791 | CIL. MAESTRO TANDEM | 77 01 208 402 , 46010-AX720 |
| | 1,4 16V | | 08.2004 | | 24.5111-0455.3 | 330914 | LATIGUILLO | 82 00 129 954 , 82 00 597 210 |
| | | | 08.2004 | | 03.2123-2923.3 | 010791 | CIL. MAESTRO TANDEM | 77 01 208 402 , 46010-AX720 |
| | 1,5 dCi | | 08.2004 | | 24.5111-0455.3 | 330914 | LATIGUILLO | 82 00 129 954 , 82 00 597 210 |







| | | | | | | | | |
|--|--|--|--|--|--------------|--|--|------------------------------|
| | | | | | Denominación | Ref. OE correspondientes a las referencias ATE | | Referencia anterior / varios |
|--|--|--|--|--|--------------|--|--|------------------------------|

RENAULT

| | | | | | | | | | |
|-------------------------|--------------|--|---------|---------|----------------|--------|---------------------|-------------------------------|--|
| MODUS/GRAND MODUS (04-) | 1,5 dCi | | 05.2007 | | 24.5111-0455.3 | 330914 | LATIGUILLO | 82 00 129 954 , 82 00 597 210 | |
| | | | 05.2007 | | 03.2123-2923.3 | 010791 | CIL. MAESTRO TANDEM | 77 01 208 402 , 46010-AX720 | |
| | | | 08.2004 | | 03.2123-2923.3 | 010791 | CIL. MAESTRO TANDEM | 77 01 208 402 , 46010-AX720 | |
| | 1,6 16V | | 08.2004 | | 24.5111-0455.3 | 330914 | LATIGUILLO | 82 00 129 954 , 82 00 597 210 | |
| | | | 08.2004 | | 03.2123-2923.3 | 010791 | CIL. MAESTRO TANDEM | 77 01 208 402 , 46010-AX720 | |
| SCENIC I (JA_) (99-03) | 1,4 16V (10) | | 10.1999 | 06.2003 | 13.0460-0077.2 | 610077 | ACCESORIO PASTILLAS | | |
| | 1,4 16V (1H) | | 10.1999 | 06.2003 | 13.0460-0077.2 | 610077 | ACCESORIO PASTILLAS | | |
| | 1,4 16V (OD) | | 10.1999 | 06.2003 | 13.0460-0077.2 | 610077 | ACCESORIO PASTILLAS | | |
| | 1,4 16V (OW) | | 10.1999 | 06.2003 | 13.0460-0077.2 | 610077 | ACCESORIO PASTILLAS | | |
| | 1,6 16V (11) | | 10.1999 | 06.2003 | 13.0460-0077.2 | 610077 | ACCESORIO PASTILLAS | | |
| | 1,6 16V (OB) | | 10.1999 | 06.2003 | 13.0460-0077.2 | 610077 | ACCESORIO PASTILLAS | | |
| | 1,6 16V (OJ) | | 10.1999 | 06.2003 | 13.0460-0077.2 | 610077 | ACCESORIO PASTILLAS | | |
| | 1,8 16V | | 01.2001 | 06.2003 | 13.0460-0077.2 | 610077 | ACCESORIO PASTILLAS | | |
| | 1,9 dCi (01) | | 06.2000 | 06.2003 | 13.0460-0077.2 | 610077 | ACCESORIO PASTILLAS | | |
| | 1,9 dCi (05) | | 06.2000 | 06.2003 | 13.0460-0077.2 | 610077 | ACCESORIO PASTILLAS | | |
| | 1,9 dCi (1F) | | 06.2000 | 06.2003 | 13.0460-0077.2 | 610077 | ACCESORIO PASTILLAS | | |
| | 1,9 dTi (1U) | | 01.2001 | 06.2003 | 13.0460-0077.2 | 610077 | ACCESORIO PASTILLAS | | |
| | 1,9 dTi (ON) | | 10.1999 | 06.2003 | 13.0460-0077.2 | 610077 | ACCESORIO PASTILLAS | | |
| | 2,0 16V | | 03.2000 | 06.2003 | 13.0460-0077.2 | 610077 | ACCESORIO PASTILLAS | | |
| | 2,0 16V (1B) | | 06.2000 | 06.2003 | 13.0460-0077.2 | 610077 | ACCESORIO PASTILLAS | | |





| | | | | | | | |
|---|---|---|---|---|--------------|--|--|
|  |  |  |  |  | Denominación | Ref. OE correspondientes a las referencias ATE |  Referencia anterior / varios |
|---|---|---|---|---|--------------|--|--|

RENAULT

| Modelo | Motor | Fecha 1 | Fecha 2 | Ref. ATE 1 | Ref. ATE 2 | Denominación | Ref. OE correspondientes a las referencias ATE | Referencia anterior / varios |
|-------------------------|---------------|---------|---------|----------------|------------|---------------------|--|------------------------------|
| SCENIC I (JA_) (99-03) | 2,0 16V (1D) | 06.2000 | 06.2003 | 13.0460-0077.2 | 610077 | ACCESORIO PASTILLAS | | |
| | 2,0 16V (OC) | 06.2000 | 06.2003 | 13.0460-0077.2 | 610077 | ACCESORIO PASTILLAS | | |
| SCENIC II (JM_) (03-09) | 1,4 16V | 06.2003 | 03.2009 | 13.0460-0077.2 | 610077 | ACCESORIO PASTILLAS | | |
| | 1,5 dCi | 11.2003 | 03.2009 | 13.0460-0077.2 | 610077 | ACCESORIO PASTILLAS | | |
| | | 06.2003 | 03.2009 | 13.0460-0077.2 | 610077 | ACCESORIO PASTILLAS | | |
| | | 05.2005 | 03.2009 | 13.0460-0077.2 | 610077 | ACCESORIO PASTILLAS | | |
| | 1,6 | 06.2006 | 03.2009 | 13.0460-0077.2 | 610077 | ACCESORIO PASTILLAS | | |
| | 1,6 16V | 06.2003 | 03.2009 | 13.0460-0077.2 | 610077 | ACCESORIO PASTILLAS | | |
| | 1,9 D | 06.2006 | 03.2009 | 13.0460-0077.2 | 610077 | ACCESORIO PASTILLAS | | |
| | 1,9 dCi | 06.2003 | 03.2009 | 13.0460-0077.2 | 610077 | ACCESORIO PASTILLAS | | |
| | | 05.2005 | 03.2009 | 13.0460-0077.2 | 610077 | ACCESORIO PASTILLAS | | |
| | 2,0 16V | 06.2003 | 03.2009 | 13.0460-0077.2 | 610077 | ACCESORIO PASTILLAS | | |
| | 2,0 16V Turbo | 05.2004 | 03.2009 | 13.0460-0077.2 | 610077 | ACCESORIO PASTILLAS | | |
| | 2,0 dCi 110 | 09.2005 | 03.2009 | 13.0460-0077.2 | 610077 | ACCESORIO PASTILLAS | | |





| | | | | | | |
|---|---|---|---|---------------------|---|---|
|  |  |   |  | Denominación | Ref. OE correspondientes a las referencias ATE |  Referencia anterior / varios |
|---|---|---|---|---------------------|---|---|

SUZUKI

| | | | | | | | | | |
|-----------------|---------------|--|---------|--|----------------|--------|----------------|------------------------------------|--|
| SPLASH (08-) | 1,0 i 12V | | 01.2008 | | 24.0120-0211.1 | 420211 | DISCO DE FRENO | 47 08 241 , 93192978 , 55311-62J00 | |
| | 1,2 i 16V | | 01.2008 | | 24.0120-0211.1 | 420211 | DISCO DE FRENO | 47 08 241 , 93192978 , 55311-62J00 | |
| | 1,3 CDTi | | 01.2008 | | 24.0120-0211.1 | 420211 | DISCO DE FRENO | 47 08 241 , 93192978 , 55311-62J00 | |
| SWIFT III (05-) | 1,3 DDiS | | 08.2005 | | 24.0120-0211.1 | 420211 | DISCO DE FRENO | 47 08 241 , 93192978 , 55311-62J00 | |
| | 1,3 i 16V | | 02.2005 | | 24.0120-0211.1 | 420211 | DISCO DE FRENO | 47 08 241 , 93192978 , 55311-62J00 | |
| | 1,3 i 16V 4x4 | | 01.2006 | | 24.0120-0211.1 | 420211 | DISCO DE FRENO | 47 08 241 , 93192978 , 55311-62J00 | |
| | 1,5 VVTi | | 02.2005 | | 24.0120-0211.1 | 420211 | DISCO DE FRENO | 47 08 241 , 93192978 , 55311-62J00 | |



| | | | | | | | |
|---|---|---|---|---|--------------|--|--|
|  |  |  |  |  | Denominación | Ref. OE correspondientes a las referencias ATE |  Referencia anterior / varios |
|---|---|---|---|---|--------------|--|--|

TOYOTA

| | | | | | | | | | |
|-----------------------|-------------------|----|---------|---------|----------------|--------|----------------|-------------|--|
| AVENSIS (03-) | 1,6 i 16V | DI | 04.2003 | | 24.5262-0576.3 | 330923 | LATIGUILLO | 90947-02D23 | |
| | 1,8 i 16V | DI | 04.2003 | | 24.5262-0576.3 | 330923 | LATIGUILLO | 90947-02D23 | |
| | 2,0 D-4D | DI | 04.2003 | | 24.5262-0576.3 | 330923 | LATIGUILLO | 90947-02D23 | |
| | | DI | 03.2006 | | 24.5262-0576.3 | 330923 | LATIGUILLO | 90947-02D23 | |
| | 2,0 i 16V | DI | 04.2003 | | 24.5262-0576.3 | 330923 | LATIGUILLO | 90947-02D23 | |
| | 2,2 D-4D | DI | 10.2005 | | 24.5262-0576.3 | 330923 | LATIGUILLO | 90947-02D23 | |
| | 2,2 D-CAT | DI | 07.2005 | | 24.5262-0576.3 | 330923 | LATIGUILLO | 90947-02D23 | |
| | 2,4 i 16V | DI | 10.2003 | | 24.5262-0576.3 | 330923 | LATIGUILLO | 90947-02D23 | |
| | | DI | 09.2003 | | 24.5262-0576.3 | 330923 | LATIGUILLO | 90947-02D23 | |
| AVENSIS VERSO (01-05) | 2,0 D4-D (CLM20) | DD | 08.2001 | 07.2005 | 24.5263-0576.3 | 330925 | LATIGUILLO | 90947-02C77 | |
| | 2,0 VVTi (ACM20) | DD | 08.2001 | 07.2005 | 24.5263-0576.3 | 330925 | LATIGUILLO | 90947-02C77 | |
| CAMRY (01-05) | 2,0 VVTi (ACV31) | | 12.2001 | 12.2005 | 24.0128-0212.1 | 428212 | DISCO DE FRENO | 43512-48011 | |
| | 2,4 VVTi (ACV30) | | 12.2001 | 12.2005 | 24.0128-0212.1 | 428212 | DISCO DE FRENO | 43512-48011 | |
| | 3,0 i V6 (MCV30) | | 12.2001 | 12.2005 | 24.0128-0212.1 | 428212 | DISCO DE FRENO | 43512-48011 | |
| COROLLA VERSO (02-04) | 1,4 VVTi (ZZE120) | DI | 06.2002 | 05.2004 | 24.5262-0576.3 | 330923 | LATIGUILLO | 90947-02D23 | |
| | 1,6 VVTi (ZZE121) | DI | 06.2002 | 05.2004 | 24.5262-0576.3 | 330923 | LATIGUILLO | 90947-02D23 | |
| | 2,0 D-4D (CDE120) | DI | 06.2002 | 05.2004 | 24.5262-0576.3 | 330923 | LATIGUILLO | 90947-02D23 | |
| COROLLA VERSO (04-) | 1,6 VVTi (ZNR10) | DI | 05.2004 | | 24.5262-0576.3 | 330923 | LATIGUILLO | 90947-02D23 | |
| | 1,8 VVTi (ZNR11) | DI | 05.2004 | | 24.5262-0576.3 | 330923 | LATIGUILLO | 90947-02D23 | |





| | | | | | | | | |
|--|--|--|--|--|--------------|--|--|------------------------------|
| | | | | | Denominación | Ref. OE correspondientes a las referencias ATE | | Referencia anterior / varios |
|--|--|--|--|--|--------------|--|--|------------------------------|

TOYOTA

| | | | | | | | | | |
|---------------------|-------------------|----|---------|---------|----------------|--------|--------------------|---------------------------|------------|
| COROLLA VERSO (04-) | 2,0 D-4D (CUR10) | DI | 05.2004 | 08.2005 | 24.5262-0576.3 | 330923 | LATIGUILLO | 90947-02D23 | |
| | 2,2 D-4D (AUR10) | DI | 09.2005 | | 24.5262-0576.3 | 330923 | LATIGUILLO | 90947-02D23 | |
| PICNIC (96-01) | 2,0 i 16V (SXM10) | DD | 09.1996 | 12.2001 | 24.5264-0525.3 | 330926 | LATIGUILLO | 90947-02887 | |
| | 2,2 TD (CXM10) | DD | 09.1997 | 04.2001 | 24.5264-0525.3 | 330926 | LATIGUILLO | 90947-02887 | |
| RAV4 III (05-) | 2,0 VVTi | | 03.2006 | | 13.0460-5766.2 | 605766 | PASTILLAS DE FRENO | 04465-42140 , 04465-42150 | ver figura |
| | 2,2 D-4D | | 03.2006 | | 13.0460-5766.2 | 605766 | PASTILLAS DE FRENO | 04465-42140 , 04465-42150 | ver figura |
| | 2,2 D-CAT | | 03.2006 | | 13.0460-5766.2 | 605766 | PASTILLAS DE FRENO | 04465-42140 , 04465-42150 | ver figura |



| | | | | | | | |
|---|---|---|---|---|---------------------|---|--|
|  |  |  |  |  | Denominación | Ref. OE correspondientes a las referencias ATE |  Referencia anterior / varios |
|---|---|---|---|---|---------------------|---|--|

VOLKSWAGEN

| Modelo | Motor | Fecha 1 | Fecha 2 | Ref. ATE | Ref. OE | Denominación | Ref. OE correspondientes a las referencias ATE | Referencia anterior / varios |
|----------------|-----------------|---------|---------|----------------|---------|---------------------|--|------------------------------|
| GOLF V (03-08) | 2,0 GTI | 09.2004 | | 03.2123-3223.3 | 010807 | CIL. MAESTRO TANDEM | 1K1 614 019 A | |
| | 3,2 R32 | 11.2005 | | 03.2123-3223.3 | 010807 | CIL. MAESTRO TANDEM | 1K1 614 019 A | |
| TIGUAN (07-) | 1,4 TSI | 11.2007 | | 13.0460-7242.2 | 607242 | PASTILLAS DE FRENO | 5N0 698 151 | ver figura |
| | 2,0 TDI 4motion | 11.2007 | | 13.0460-7242.2 | 607242 | PASTILLAS DE FRENO | 5N0 698 151 | ver figura |
| | | 01.2008 | | 13.0460-7242.2 | 607242 | PASTILLAS DE FRENO | 5N0 698 151 | ver figura |
| | 2,0 TSI 4motion | 11.2007 | | 13.0460-7242.2 | 607242 | PASTILLAS DE FRENO | 5N0 698 151 | ver figura |
| | | 02.2008 | | 13.0460-7242.2 | 607242 | PASTILLAS DE FRENO | 5N0 698 151 | ver figura |
| TOUAREG (03-) | 2,5 R5 TDI | 01.2006 | | 13.0460-4834.2 | 604834 | PASTILLAS DE FRENO | 7L6 698 451 B | ver figura |
| | 3,0 V6 TDI | 01.2006 | | 13.0460-4834.2 | 604834 | PASTILLAS DE FRENO | 7L6 698 451 B | ver figura |
| | | 10.2007 | | 13.0460-4834.2 | 604834 | PASTILLAS DE FRENO | 7L6 698 451 B | ver figura |
| | 3,2 V6 | 11.2002 | 12.2005 | 13.0460-4834.2 | 604834 | PASTILLAS DE FRENO | 7L6 698 451 B | ver figura |
| | 3,6 V6 FSI | 01.2006 | | 13.0460-4834.2 | 604834 | PASTILLAS DE FRENO | 7L6 698 451 B | ver figura |
| | 4,2 V8 | 01.2006 | 11.2006 | 13.0460-4834.2 | 604834 | PASTILLAS DE FRENO | 7L6 698 451 B | ver figura |
| | 4,2 V8 FSI | 12.2006 | | 13.0460-4834.2 | 604834 | PASTILLAS DE FRENO | 7L6 698 451 B | ver figura |
| | 5,0 TDI R50 | 01.2008 | | 13.0460-4834.2 | 604834 | PASTILLAS DE FRENO | 7L6 698 451 B | ver figura |
| | 5,0 V10 TDI | 01.2006 | | 13.0460-4834.2 | 604834 | PASTILLAS DE FRENO | 7L6 698 451 B | ver figura |
| | 6,0 W12 | 01.2006 | 11.2006 | 13.0460-4834.2 | 604834 | PASTILLAS DE FRENO | 7L6 698 451 B | ver figura |



13.0460-4814.2 604814

Aplicación:

PORSCHE BOXSTER (986) (96-04)

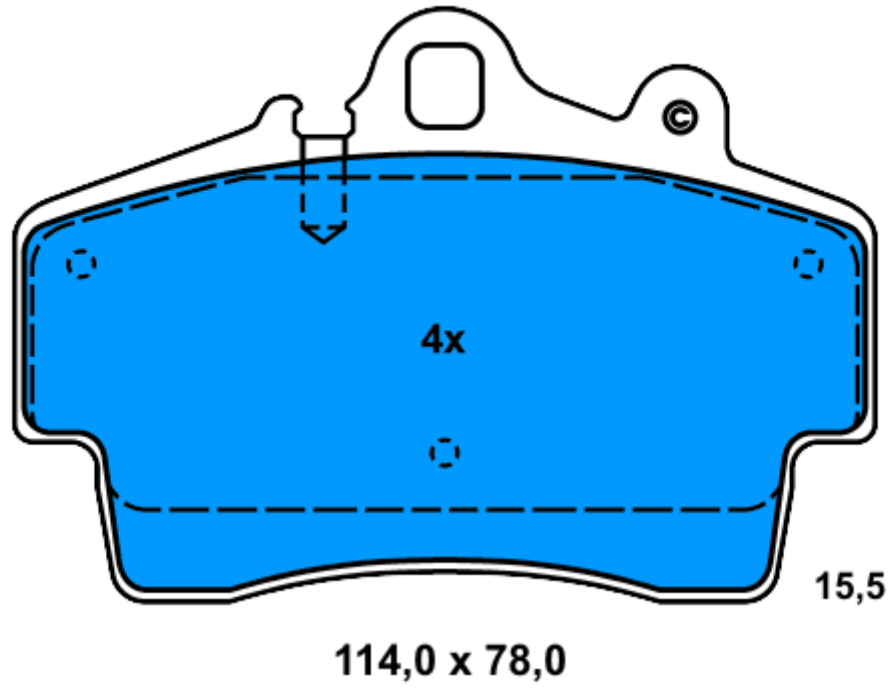



13.0460-4837.2 604837

Aplicación:

LAND ROVER RANGE ROVER III (LM) (02-)
LAND ROVER RANGE ROVER SPORT (05-)

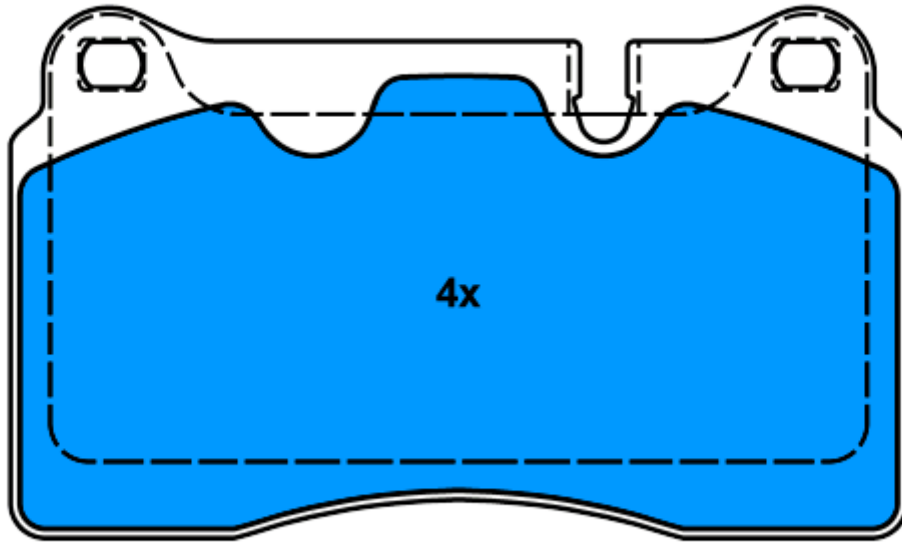

131,6 x 77,3

24098 17,1



13.0460-7242.2 607242

Aplicación:

VOLKSWAGEN TIGUAN (07-)

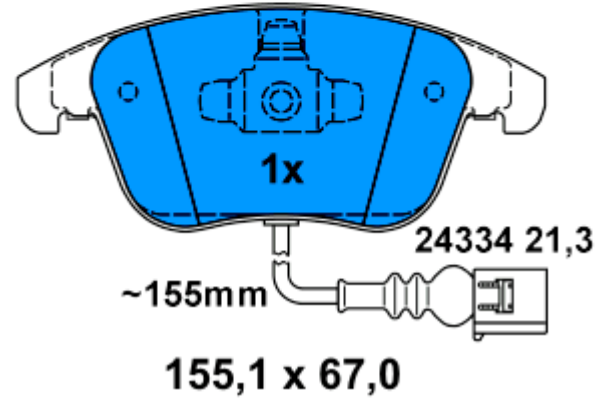
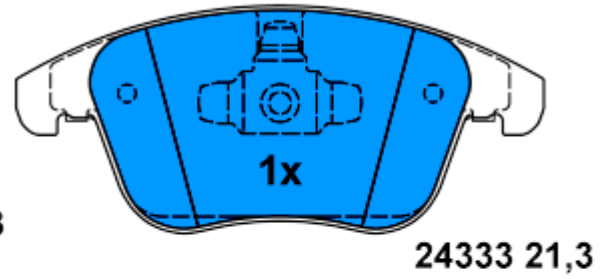
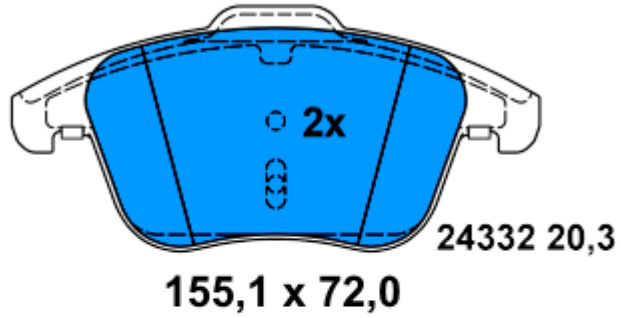



13.0460-5766.2 605766

Aplicación:
TOYOTA RAV4 III (05-)

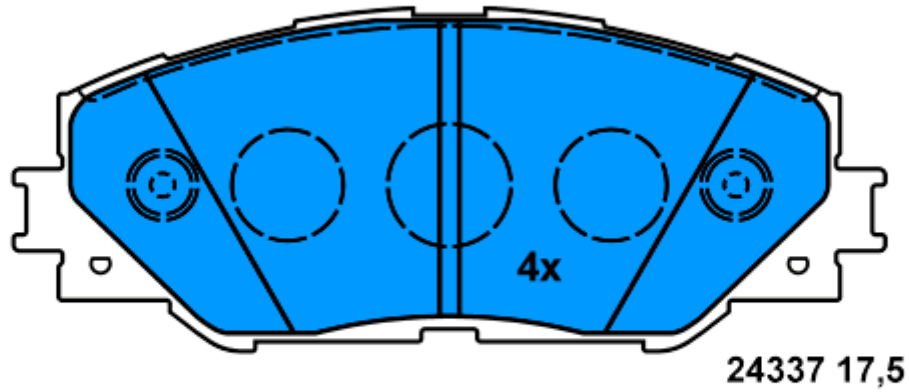

146,4 x 56,8



13.0460-5756.2 605756

Aplicación:

HONDA CIVIC (5-puertas) (06-)
HONDA CIVIC S (06-)

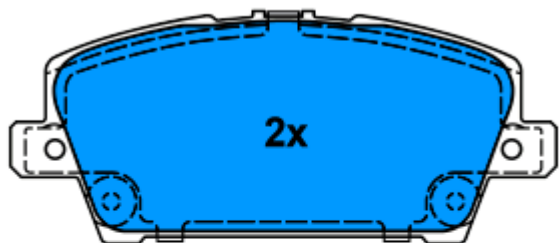

24087 17,4

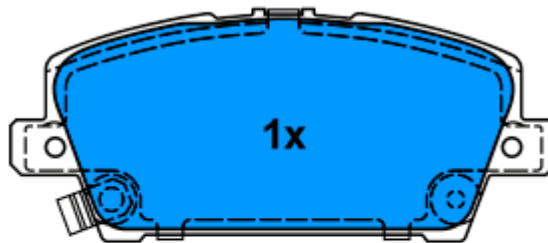

24405 17,4

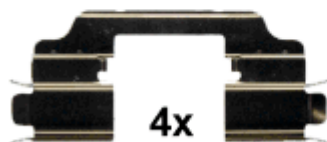

4x



4x

M8x22

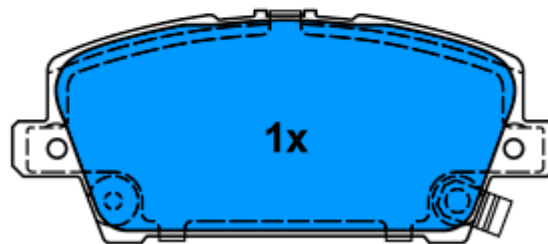

1x

24406 17,4

131,5 x 55,7



13.0460-7244.2 607244

Aplicación:

MERCEDES BENZ Clase C (S204) Break (07-)
MERCEDES BENZ Clase C (W204) Berlina (07-)

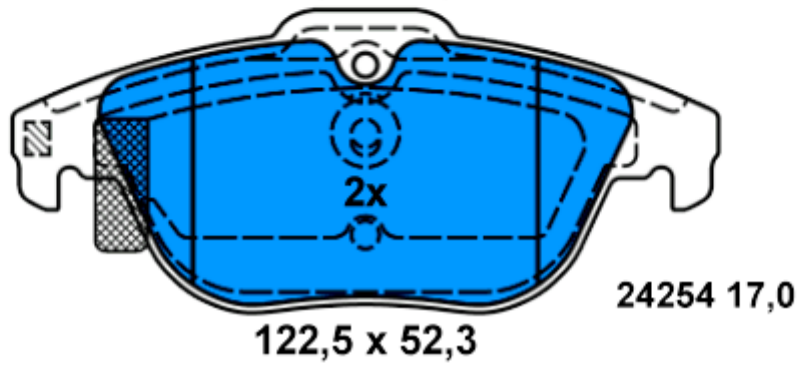
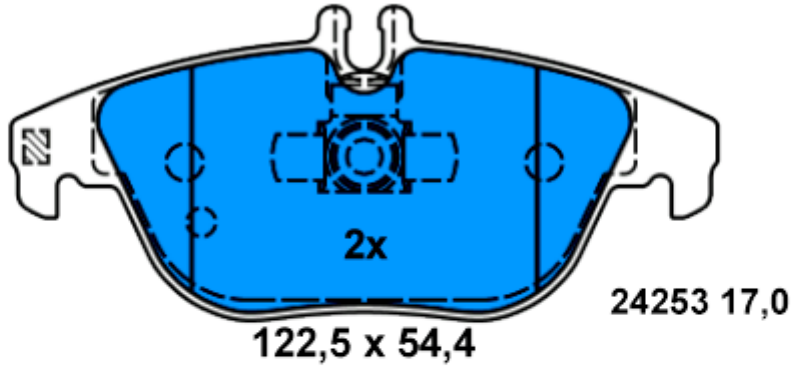



13.0460-4834.2 604834

Aplicación:

VOLKSWAGEN TOUAREG (03-)

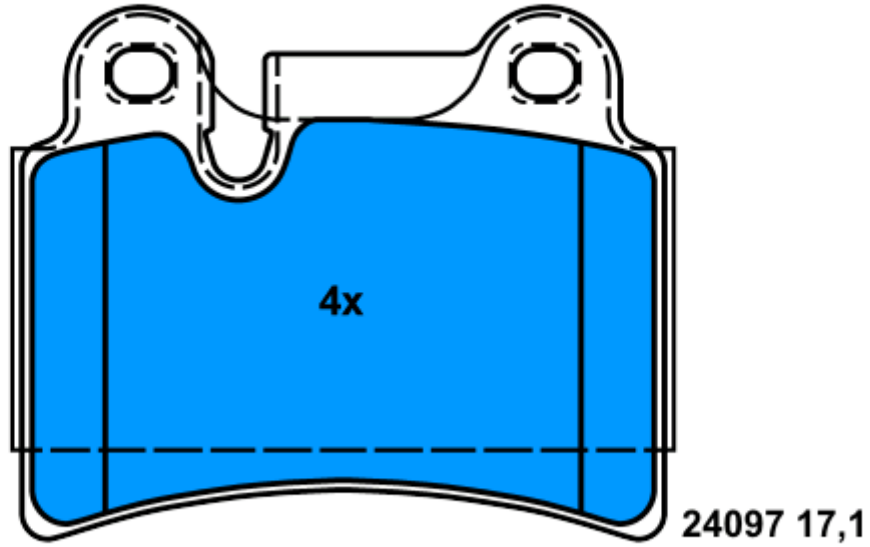



13.0460-7258.2 607258

Aplicación:
LANCIA DELTA (08-)

